



Operating Manual

QuickServer FS-QS-2XX0 Start-up Guide



Revision: 2.0

Document No.: T18627

Print Spec: 10000005389 (F)



fieldserver

MSA Safety
1000 Cranberry Woods Drive
Cranberry Township, PA 16066 USA

U.S. Support Information:
+1 408 964-4443
+1 800 727-4377
Email: smc-support@msasafety.com

EMEA Support Information:
+31 33 808 0590
Email: smc-support.emea@msasafety.com

For your local MSA contacts, please go to our website www.MSAsafety.com

Contents

1	About the QuickServer	5
1.1	Certification	5
1.2	Supplied Equipment	5
2	Equipment Setup	6
2.1	Mounting	6
2.2	Physical Dimensions	7
3	Installation	8
3.1	DIP Switch Settings	8
3.1.1	Bias Resistors	8
3.1.2	Termination Resistor	9
3.2	Connecting the R1 & R2 Ports	10
3.2.1	Wiring	10
3.2.2	Supported RS-485 Baud Rates by Protocol	10
3.3	10/100 Ethernet Connection Port	11
4	Power up the Gateway	12
5	Connect the PC to the Gateway	13
5.1	Connecting to the Gateway via Ethernet	13
5.1.1	Changing the Subnet of the Connected PC	13
5.2	Navigate to the Login Page	13
6	Setup Web Server Security	14
6.1	Login to the FieldServer	14
6.2	Select the Security Mode	16
6.2.1	HTTPS with Own Trusted TLS Certificate	17
6.2.2	HTTPS with Default Untrusted Self-Signed TLS Certificate or HTTP with Built-in Payload Encryption	17
7	Setup Network	18
7.1	Using FS-GUI to Input Network Settings	19
7.2	Routing Settings	20
7.3	Ethernet 1 Network Settings	21
8	Configuring the QuickServer	22
8.1	Retrieve the Sample Configuration File	22
8.2	Change the Configuration File to Meet the Application	22
8.3	Load the Updated Configuration File	23
8.3.1	Using the FS-GUI to Load a Configuration File	23
8.3.2	Retrieve the Configuration File for Modification or Backup	24
8.4	Test and Commission the QuickServer	25
8.4.1	Accessing the FieldServer Manager	25
9	MSA Grid - FieldServer Manager Setup	26
9.1	Registration Process	26
9.2	User Setup	29
9.3	Finish Registering the FieldServer	31
9.4	Login to the FieldServer Manager	33

10	Troubleshooting	35
10.1	Communicating with the QuickServer Over the Network	35
10.2	Taking a FieldServer Diagnostic Capture	36
10.3	LED Functions	37
10.4	Factory Reset Instructions	38
10.5	Internet Browser Software Support	38
11	Additional Information	39
11.1	Change Web Server Security Settings After Initial Setup	39
11.1.1	Change Security Mode	40
11.1.2	Edit the Certificate Loaded onto the FieldServer	41
11.2	Change User Management Settings	42
11.2.1	Create Users	43
11.2.2	Edit Users	44
11.2.3	Delete Users	45
11.2.4	Change FieldServer Password	46
11.3	QuickServer Part Numbers	47
11.4	Compliance with UL Regulations	48
11.5	Specifications	49
11.6	FieldServer Manager Connection Warning Message	50
12	Limited 2 Year Warranty	51

1 About the QuickServer

The QuickServer is a high performance, cost effective Building and Industrial Automation multi-protocol gateway providing protocol translation between serial/Ethernet devices and networks.

NOTE: For troubleshooting assistance refer to [Section 10 Troubleshooting](#), or any of the troubleshooting appendices in the related driver supplements. Check the [MSA Safety website](#) for technical support resources and documentation that may be of assistance.

The QuickServer is cloud ready and connects with MSA Safety's Grid. See [Section 9 MSA Grid - FieldServer Manager Setup](#) for further information.

NOTE: The FS-QS-2XX0-F contains all Serial and Ethernet drivers.

1.1 Certification



BTL Mark – BACnet Testing Laboratory

The BTL Mark on the FieldServer is a symbol that indicates that a product has passed a series of rigorous tests conducted by an independent laboratory which verifies that the product correctly implements the BACnet features claimed in the listing. The mark is a symbol of a high-quality BACnet product.

Go to www.BACnetInternational.net for more information about the BACnet Testing Laboratory. Click [here](#) for the BACnet PIC Statement. *BACnet is a registered trademark of ASHRAE.*

1.2 Supplied Equipment

FieldServer Gateway

- Preloaded with two selected drivers. A sample configuration file is also loaded.
- All instruction manuals, driver manuals, support utilities are available on the USB drive provided in the optional accessory kit, or on the MSA website.

Accessory kit (optional) (Part # FS-8915-38-QS) includes:

- 7-ft Cat-5 cable with RJ45 connectors at both ends
- Power Supply -110/220V (p/n 69196)
- Screwdriver for connecting to terminals
- USB Flash drive loaded with:
 - Start-up Guide
 - FieldServer Configuration Manual
 - All FieldServer Driver Manuals
 - Support Utilities
 - Any additional folders related to special files configured for a specific FieldServer
 - Additional components as required - see driver manual supplement for details

2 Equipment Setup

2.1 Mounting

The gateway can be mounted using the DIN rail mounting bracket on the back of the unit.



2.2 Physical Dimensions

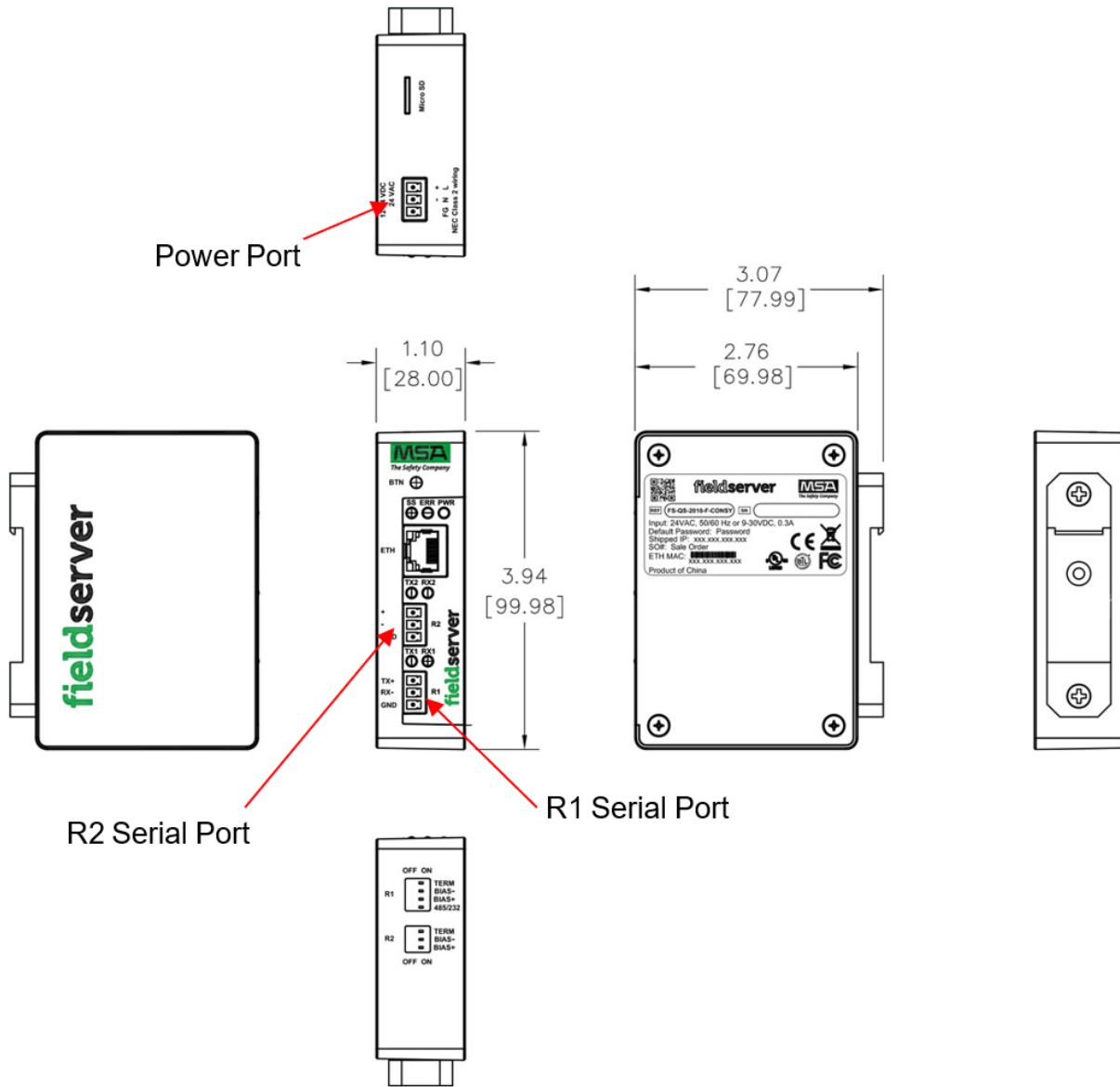

3 Installation

3.1 DIP Switch Settings

3.1.1 Bias Resistors

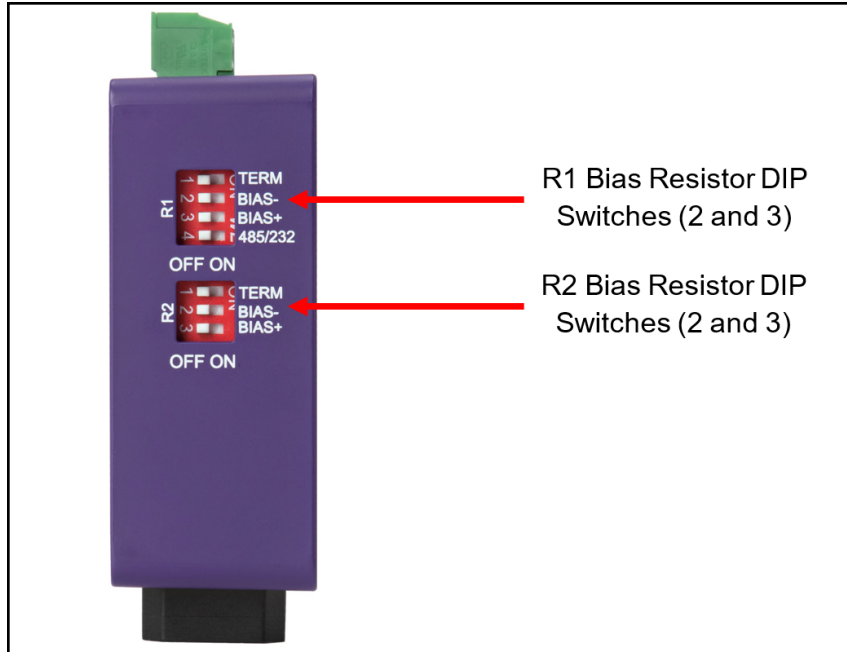

To enable Bias Resistors, move both the BIAS- and BIAS+ dip switches to the right in the orientation shown above.

The bias resistors are used to keep the RS-485 bus to a known state, when there is no transmission on the line (bus is idling), to help prevent false bits of data from being detected. The bias resistors typically pull one line high and the other low - far away from the decision point of the logic.

The bias resistor is 510 ohms which is in line with the BACnet spec. It should only be enabled at one point on the bus (for example, on the field port where there are very weak bias resistors of 100k). Since there are no jumpers, many QuickServers can be put on the network without running into the bias resistor limit which is < 500 ohms.

NOTE: See the [Termination and Bias Resistance Enote](#) for additional information.

NOTE: The R1 and R2 DIP Switches apply settings to the respective serial port.

NOTE: If the gateway is already powered on, DIP switch settings will not take effect unless the unit is power cycled.

3.1.2 Termination Resistor

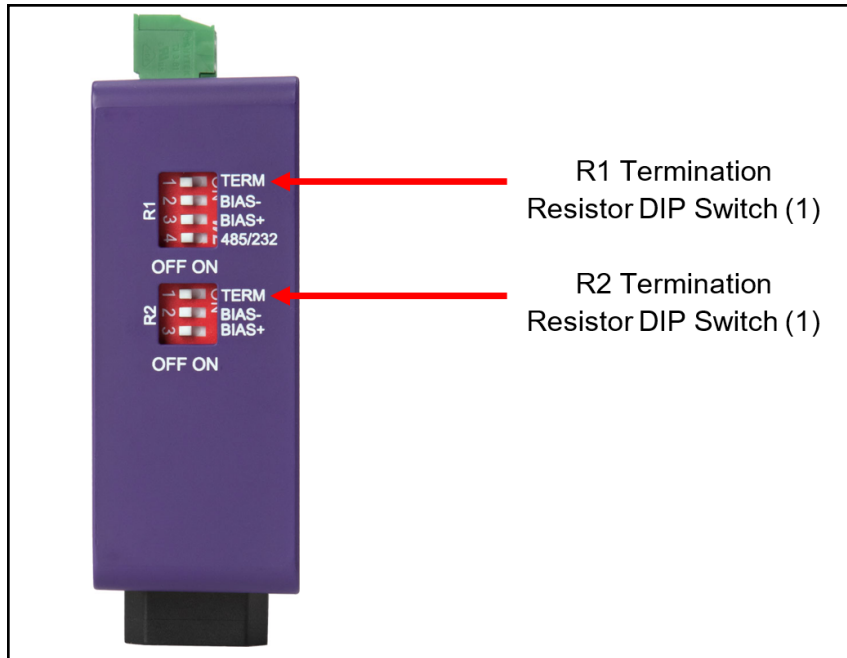

If the gateway is the last device on the serial trunk, then the End-Of-Line Termination Switch needs to be enabled. **To enable the Termination Resistor, move the TERM dip switch to the right in the orientation shown in above.**

Termination resistor is also used to reduce noise. It pulls the two lines of an idle bus together. However, the resistor would override the effect of any bias resistors if connected.

NOTE: The R1 and R2 DIP Switches apply settings to the respective serial port.

NOTE: If the gateway is already powered on, DIP switch settings will not take effect unless the unit is power cycled.

3.2 Connecting the R1 & R2 Ports

For the R1 Port only: Switch between RS-485 and RS-232 by moving the number 4 DIP Switch left for RS-485 and right for RS-232 (see images in **Section 3.1 DIP Switch Settings**).

The R2 Port is RS-485.

Connect to the 3-pin connector(s) as shown below.

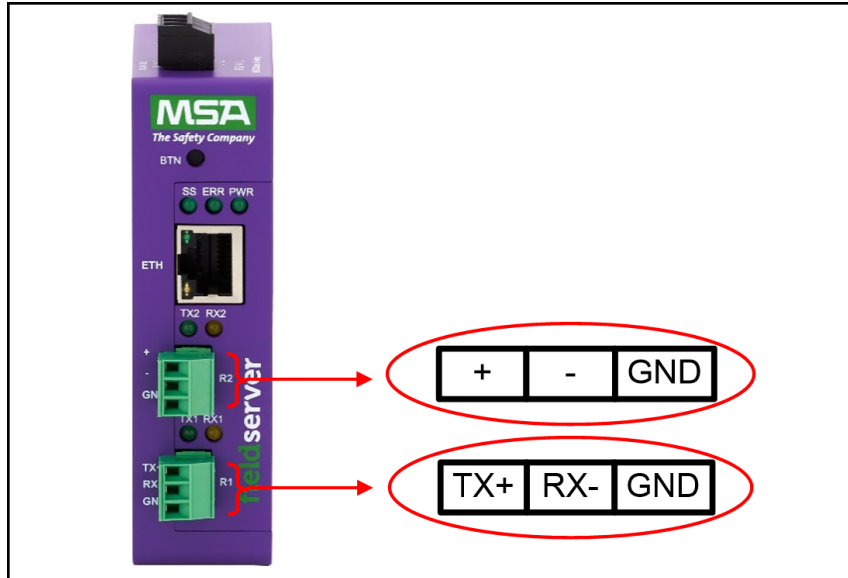

3.2.1 Wiring

RS-485		RS-232	
BMS RS-485 Wiring	Gateway Pin Assignment	BMS RS-485 Wiring	Gateway Pin Assignment
RS-485 +	TX +	RS-232 -	TX +
RS-485 -	RX -	RS-232 +	RX -
GND	GND	GND	GND

NOTE: Use standard grounding principles for GND.

3.2.2 Supported RS-485 Baud Rates by Protocol

The supported baud rates for either port is based on the protocol of the connected devices.

The following baud rates are supported for Modbus RTU:

2400, 4800, 9600, 19200, 38400, 57600, 76800, 115200

The following baud rates are supported for BACnet MS/TP:

9600, 19200, 38400, 76800, 115200

3.3 10/100 Ethernet Connection Port

NOTE: Do not use shielded Ethernet cables.

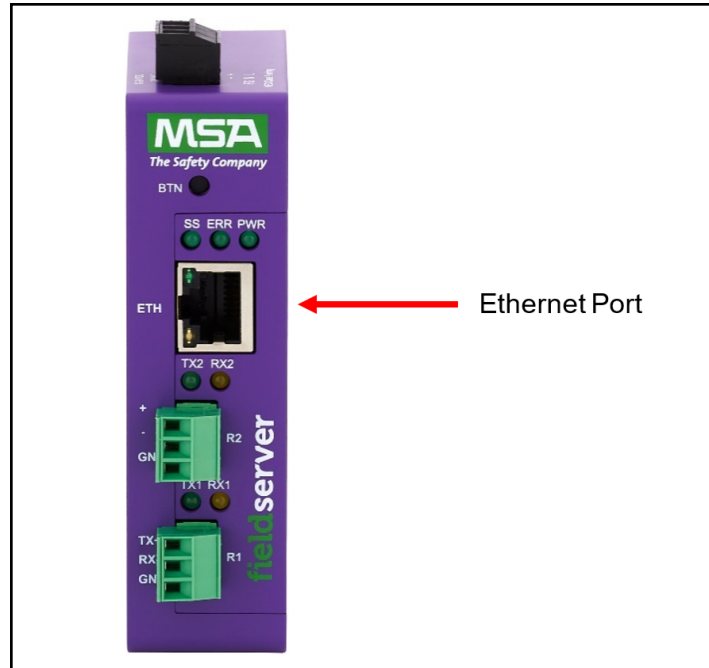

The Ethernet Port is used both for Ethernet protocol communications and for configuring the gateway via the Web App. To connect the gateway, either connect the PC to the router's Ethernet port or connect the router and PC to an Ethernet switch. Use Cat-5 cables for the connection.

NOTE: The Default IP Address of the gateway is 192.168.2.101, Subnet Mask is 255.255.255.0.

4 Power up the Gateway

Check power requirements in the table below:

Power Requirement for QuickServer External Gateway		
	Current Draw Type	
QuickServer Family	12VDC	24VDC/AC
FS-QS-2XX0-XXXX (Typical)	250mA	125mA

NOTE: These values are 'nominal' and a safety margin should be added to the power supply of the host system. A safety margin of 25% is recommended.

Apply power to the QuickServer as shown below. Ensure that the power supply used complies with the specifications provided in [Section 11.5 Specifications](#) .

- The gateway accepts 9-30VDC or 24VAC on pins L+ and N-.
- Frame GND should be connected.

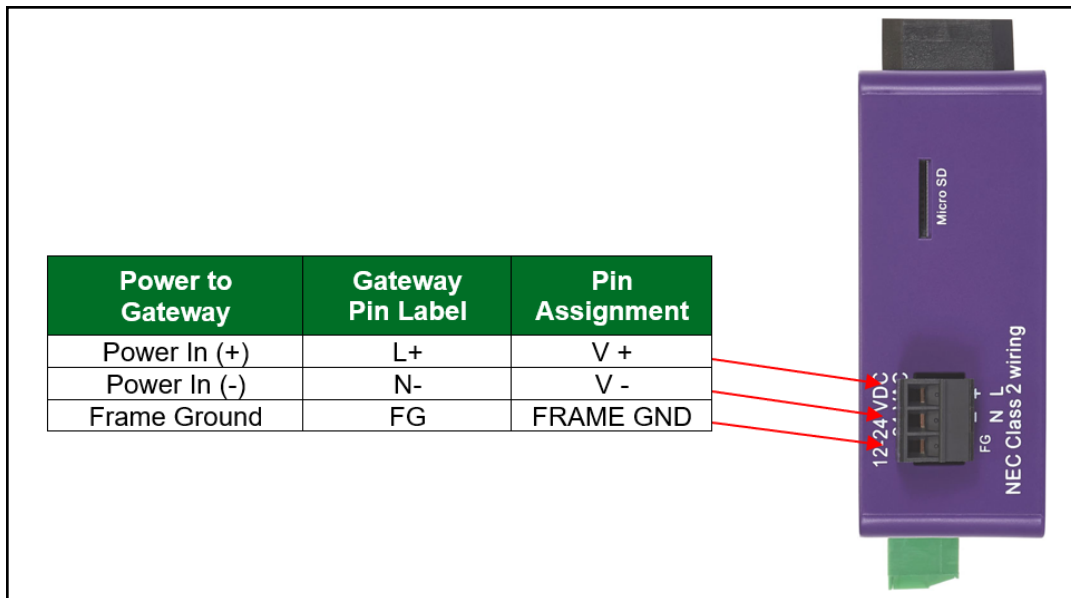

5 Connect the PC to the Gateway

5.1 Connecting to the Gateway via Ethernet

Connect a Cat-5 Ethernet cable (straight through or cross-over) between the local PC and QuickServer .

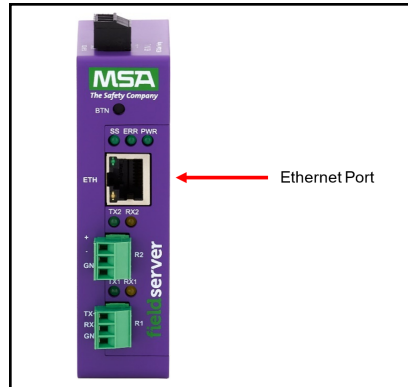

5.1.1 Changing the Subnet of the Connected PC

The default IP Address for the QuickServer is **192.168.2.101**, Subnet Mask is **255.255.255.0**. If the PC and QuickServer are on different IP networks, assign a static IP Address to the PC on the 192.168.2.xxx network.

For Windows 10:

- Use the search field in the local computer's taskbar (to the right of the windows icon ) and type in "Control Panel".
- Click "Control Panel", click "Network and Internet" and then click "Network and Sharing Center".
- Click "Change adapter settings" on the left side of the window.
- Right-click on "Local Area Connection" and select "Properties" from the dropdown menu.
- Highlight [Internet Protocol Version 4 \(TCP/IPv4\)](#) and then click the Properties button.
- Select and enter a static IP Address on the same subnet. For example:

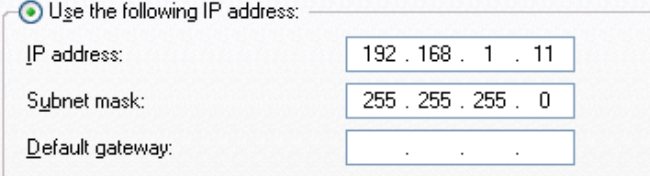

Use the following IP address:	
IP address:	192 . 168 . 1 . 11
Subnet mask:	255 . 255 . 255 . 0
Default gateway:	. . .

- Click the Okay button to close the Internet Protocol window and the Close button to exit the Ethernet Properties window.

5.2 Navigate to the Login Page

- Open a web browser and connect to the FieldServer's default IP Address. The default IP Address of the FieldServer is **192.168.2.101**, Subnet Mask is **255.255.255.0**.
- If the PC and the FieldServer are on different IP networks, assign a static IP Address to the PC on the 192.168.2.X network.

6 Setup Web Server Security

6.1 Login to the FieldServer

The first time the FieldServer GUI is opened in a browser, the IP Address for the gateway will appear as untrusted. This will cause the following pop-up windows to appear.

- When the Web Server Security Unconfigured window appears, read the text and choose whether to move forward with HTTPS or HTTP.

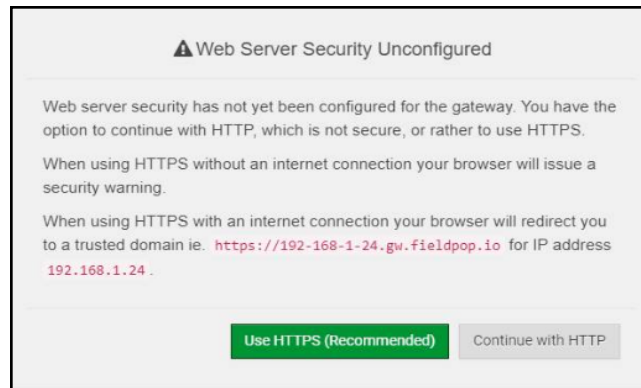

- When the warning that "Your connection is not private" appears, click the advanced button on the bottom left corner of the screen.

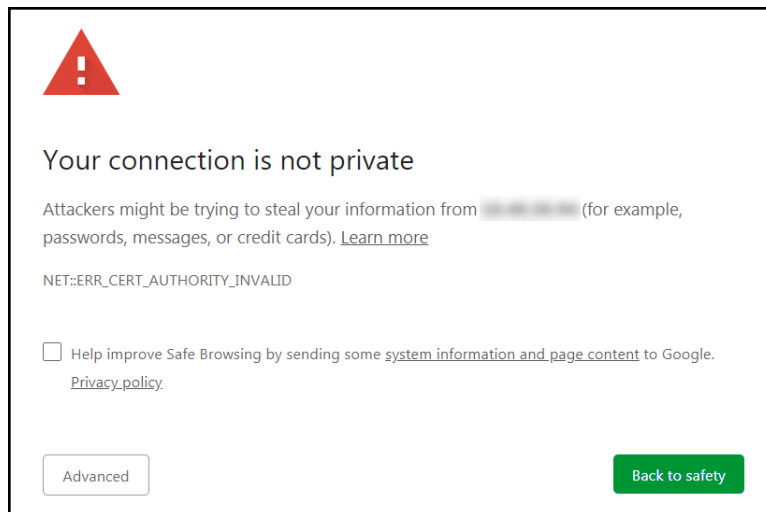

- Additional text will expand below the warning, click the underlined text to go to the IP Address. In the example below this text is “[Proceed to <FieldServer IP> \(unsafe\)](#)”.

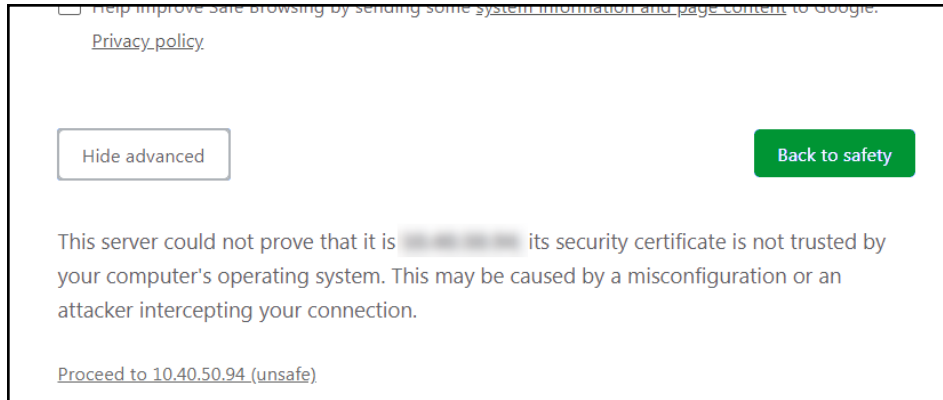

- When the login screen appears, put in the Username (default is “admin”) and the Password (found on the label of the FieldServer).

NOTE: There is also a QR code in the top right corner of the FieldServer label that shows the default unique password when scanned.

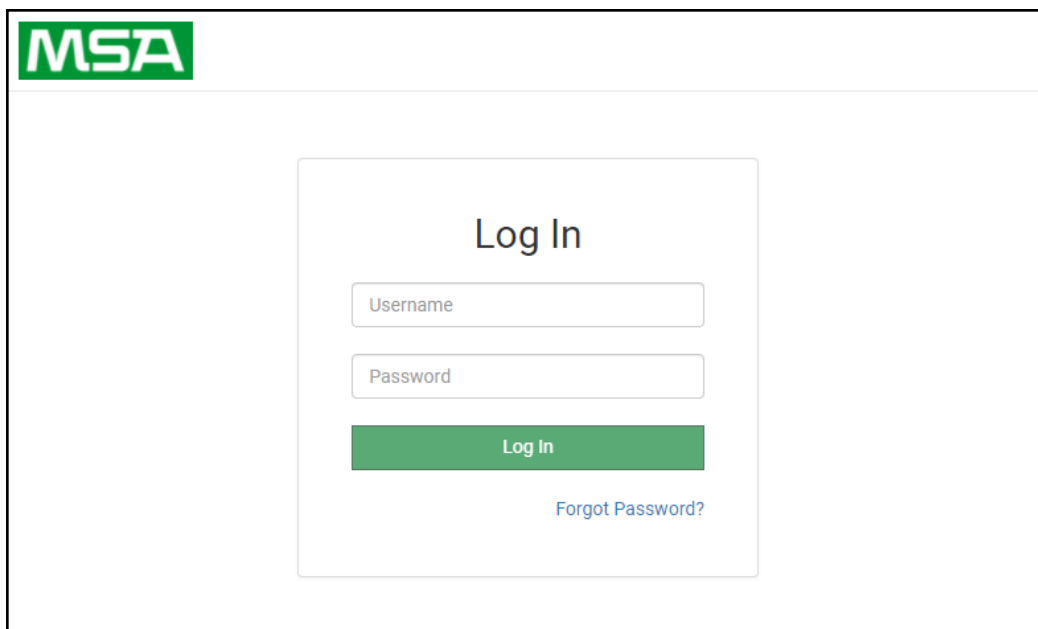

NOTE: A user has 5 attempts to login then there will be a 10-minute lockout. There is no timeout on the FieldServer to enter a password.

NOTE: To create individual user logins, go to [Section 11.2 Change User Management Settings](#).

6.2 Select the Security Mode

On the first login to the FieldServer, the following screen will appear that allows the user to select which mode the FieldServer should use.

Web server security is not configured



Please select the web security profile from the options below.

Note that browsers will issue a security warning when browsing to a HTTPS server with an untrusted self-signed certificate.

Mode

- HTTPS with default trusted TLS certificate (requires internet connection to be trusted)
- HTTPS with own trusted TLS certificate
- HTTP (not secure, vulnerable to man-in-the-middle attacks)

Save

NOTE: Cookies are used for authentication.

NOTE: To change the web server security mode after initial setup, go to [Section 11.1 Change Web Server Security Settings After Initial Setup](#).

The sections that follow include instructions for assigning the different security modes.

6.2.1 HTTPS with Own Trusted TLS Certificate

This is the recommended selection and the most secure. **Please contact your IT department to find out if you can obtain a TLS certificate from your company before proceeding with the Own Trusted TLS Certificate option.**

- Once this option is selected, the Certificate, Private Key and Private Key Passphrase fields will appear under the mode selection.

Certificate

```
XzyMbQZFIRuJZJPe7CTHLcHORHlowoUFoVTaBMYd4d6VGdNklKazByWKcNOL7mrX
A4IBAQBfM+IPvOx3T/47VEmaiXqE3bx3zEuBFJ6pWPlw7LHf2r2ZoHw+9xb+aNMU
dVYAelhBMTMsnI2ERvQVp0xj3psSv2EJyKXS1bOYNRLsq7UzpwuAdT/Wy3o6vUM5
K+Cwf9qEoQ0LuxDZTIECT67MkcHMiuFi5pk7TRicHnQF/sfOAYOulduHOy9exlk9
FmHFVDIZf/cJUaF+e74EuSph+gEr0lQo2wmmhyc7L22UXse1NoOfUJ2Zq0Eu1Vvtu
JRryaMWIRFEWuuzMGZfKEWVC+8q2JQsVcqiRWM7naoblEhOCMH+sKHJMCxDoXGt
vtZjpZUoAL51YXxWSVcyZdGiAP5e
-----END CERTIFICATE-----
```

Private Key

```
sHB0zZoHr4YQSDk2BbYVzZbI0LDuKtc8+JiO3ooGjoTuHnqkeAj/fKfbTAsKeAzw
gKQe+H5UQNk0bdvZfOJrm6daDK2vDmR5k+juUHEj5N49uplroB97MQgYotzqfT+
THlbpq5t1SIK617k04ObKMHF5l8fck+ru545sVmpeezh0m5j5SURYAZMvbq5daCu
J4l5NlIhbEvxRF4UK41ZDMCvujopCkBUWrb1a/3XXnDnM2K9xyz2wze998D6Wk46
+7aOFY9F+7j5lJmnkoS3GYtwCyH5jP+mPP1K6RnuiD019wwwGPb4dtN/RTnfd0eF
GYeVSkI9fxkxDOFtdWRZbM/rPin4tmO1Xf8HqONVN1x/iaMynOXG4cukoI4+VO
u0rZaUESll2zNkfrn7fAASm5NBWg202Cy9IAYnuujs3aALl5uGBEEK62oTMxlzx
-----END RSA PRIVATE KEY-----
```

Private Key Passphrase

- Copy and paste the Certificate and Private Key text into their respective fields. If the Private Key is encrypted type in the associated Passphrase.
- Click Save.
- A “Redirecting” message will appear. After a short time, the FieldServer GUI will open.

6.2.2 HTTPS with Default Untrusted Self-Signed TLS Certificate or HTTP with Built-in Payload Encryption

- Select one of these options and click the Save button.
- A “Redirecting” message will appear. After a short time, the FieldServer GUI will open.

7 Setup Network

Once the web server setup is complete, the FS-GUI landing page will appear.

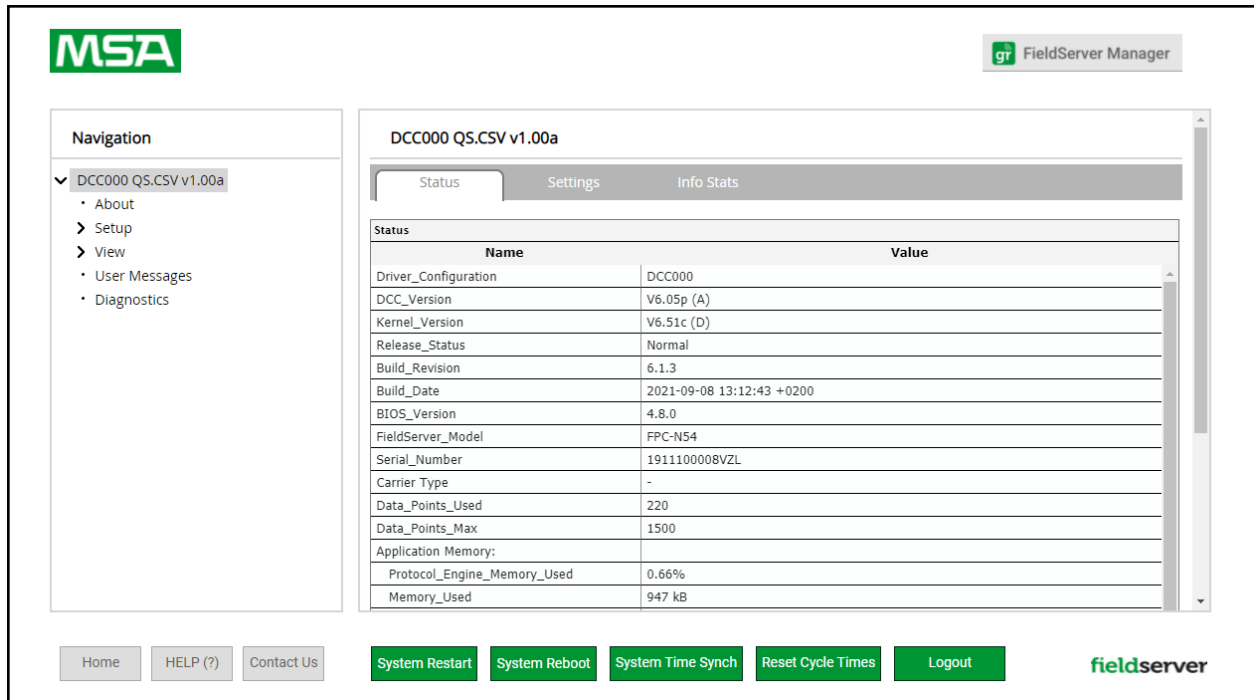

The screenshot displays the MSA FieldServer Manager interface. The top left features the MSA logo, and the top right shows the 'gr FieldServer Manager' tab. A navigation menu on the left lists 'DCC000 QS.CSV v1.00a' with sub-items: About, Setup, View, User Messages, and Diagnostics. The main content area is titled 'DCC000 QS.CSV v1.00a' and has tabs for 'Status', 'Settings', and 'Info Stats'. The 'Status' tab is active, showing a table of system parameters:

Name	Value
Driver_Configuration	DCC000
DCC_Version	V6.05p (A)
Kernel_Version	V6.51c (D)
Release_Status	Normal
Build_Revision	6.1.3
Build_Date	2021-09-08 13:12:43 +0200
BIOS_Version	4.8.0
FieldServer_Model	FPC-N54
Serial_Number	1911100008VZL
Carrier Type	-
Data_Points_Used	220
Data_Points_Max	1500
Application Memory:	
Protocol_Engine_Memory_Used	0.66%
Memory_Used	947 kB

At the bottom of the interface, there are buttons for 'Home', 'HELP (?)', 'Contact Us', 'System Restart', 'System Reboot', 'System Time Synch', 'Reset Cycle Times', and 'Logout'. The 'fieldserver' logo is visible in the bottom right corner.

NOTE: The FieldServer Manager tab  (see image above) allows users to connect to the Grid, MSA Safety's device cloud solution for IIoT. The FieldServer Manager enables secure remote connection to field devices through a FieldServer and its local applications for configuration, management, maintenance. For more information about the FieldServer Manager, refer to the [MSA Grid - FieldServer Manager Start-up Guide](#).

7.1 Using FS-GUI to Input Network Settings

To navigate from the FS-GUI page to the Network Settings page follow the below instructions:

- Find the Navigation tree across the left side of the screen.
- Click the arrow next to the FieldServer title/CN number to expand the tree.

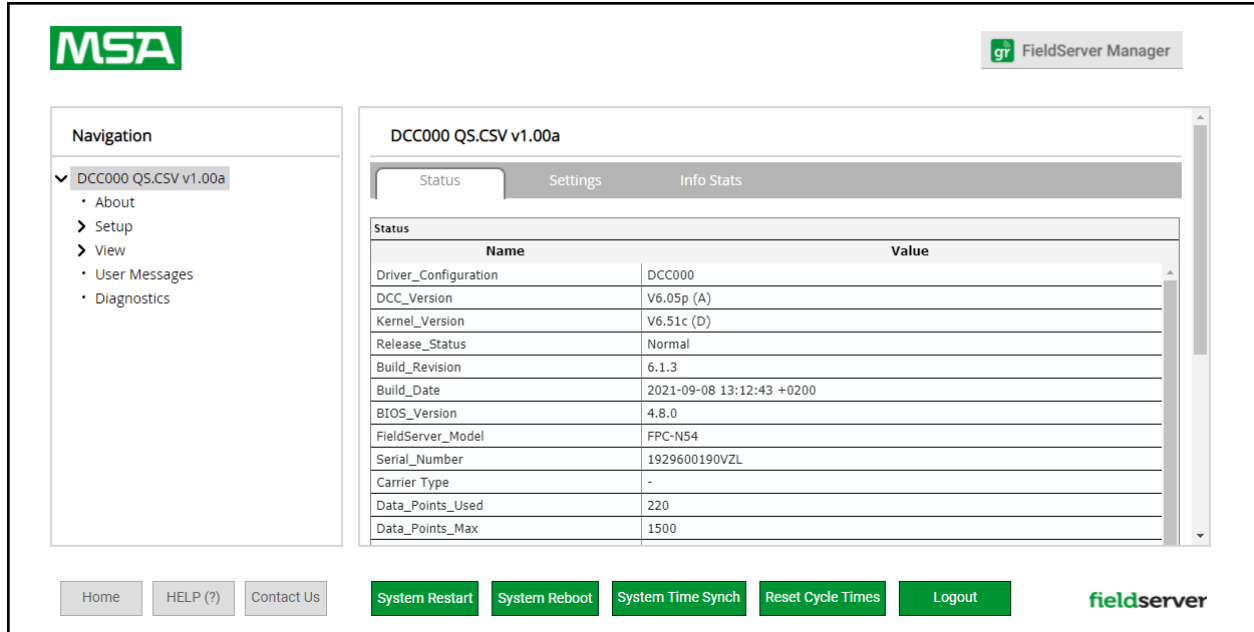

The screenshot shows the MSA FieldServer Manager interface. On the left is a navigation tree with the following items:

- Navigation
 - ▼ DCC000 QS.CSV v1.00a
 - About
 - ▶ Setup
 - ▶ View
 - User Messages
 - Diagnostics

The main content area displays the status of the FieldServer. It has tabs for Status, Settings, and Info Stats. The Status tab is active, showing a table with the following data:

Name	Value
Driver_Configuration	DCC000
DCC_Version	V6.05p (A)
Kernel_Version	V6.51c (D)
Release_Status	Normal
Build_Revision	6.1.3
Build_Date	2021-09-08 13:12:43 +0200
BIOS_Version	4.8.0
FieldServer_Model	FPC-N54
Serial_Number	1929600190VZL
Carrier_Type	-
Data_Points_Used	220
Data_Points_Max	1500

At the bottom of the interface, there are several buttons: Home, HELP (?), Contact Us, System Restart, System Reboot, System Time Synch, Reset Cycle Times, and Logout. The fieldserver logo is also present in the bottom right corner.

- Click on the arrow next to Setup to expand the tree.
- Click on Network Settings.

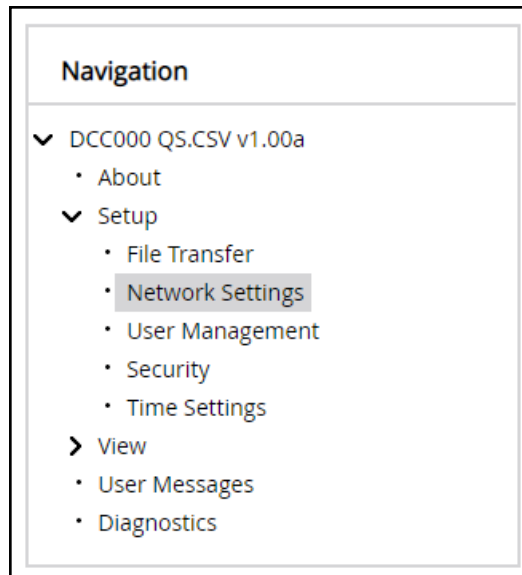

This is a close-up view of the navigation tree from the previous screenshot. The 'Setup' item is expanded, and 'Network Settings' is highlighted with a grey background. The tree structure is as follows:

- Navigation
 - ▼ DCC000 QS.CSV v1.00a
 - About
 - ▼ Setup
 - File Transfer
 - Network Settings
 - User Management
 - Security
 - Time Settings
 - ▶ View
 - User Messages
 - Diagnostics

7.2 Routing Settings





The Routing settings make it possible to set up the IP routing rules for the FieldServer's internet and network connections.

- Click the Add Rule button to add a new row and set a new Destination Network, Netmask and Gateway IP Address as needed.
- Set the Priority for each connection (1-255 with 1 as the highest priority and 255 as the lowest).
- Click the Save button to activate the new settings.



ETH 1 Routing 

Set up the IP routing rules of your FieldServer for internet access and access to other networks.

If you want to reach another device that is not connected to the local network, you can add a rule to determine on which gateway the device must be routed to.

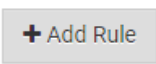
Interface	Destination Network	Netmask	Gateway IP Address	Priority 
ETH 	Default	-	10.40.50.1	255
ETH 	10.40.50.10	255.255.255.255	10.40.50.1	254 

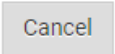
 + Add Rule

There are unsaved settings

7.3 Ethernet 1 Network Settings

To change the FieldServe IP Settings, follow these instructions:

- Enable DHCP to automatically assign IP Settings or modify the IP Settings manually as needed, via these fields: IP Address, Netmask, Default Gateway, and Domain Name Server1/2.

NOTE: If the FieldServer is connected to a router, the IP Gateway of the FieldServer should be set to the same IP Address of the router.

- Click Save to record and activate the new IP Address.
- Connect the FieldServer to the local network or router.

NOTE: The browser needs to be updated to the new IP Address of the FieldServer before the settings will be accessible again.

ETH 1 Routing

Enable DHCP

IP Address
10.40.50.109

Netmask
255.255.255.0

Gateway
10.40.50.1

Domain Name Server 1 (Optional)
10.40.2.24

Domain Name Server 2 (Optional)
10.15.130.15

Cancel Save

Network Status	
Connection Status	✔ Connected
MAC Address	00:50:4e:60:13:be
Ethernet Tx Msgs	1,209,919
Ethernet Rx Msgs	2,745,183
Ethernet Tx Msgs Dropped	0
Ethernet Rx Msgs Dropped	0

8 Configuring the QuickServer

8.1 Retrieve the Sample Configuration File

The configuration of the QuickServer is provided to the QuickServer's operating system via a comma-delimited file called "CONFIG.CSV".

If a custom configuration was ordered, the QuickServer will be programmed with the relevant device registers in the Config.csv file for the initial start-up. If not, the product is shipped with a sample config.csv that shows an example of the drivers ordered.

- In the main menu of the FS-GUI screen, go to "Setup", then "File Transfer", and finally "Retrieve".
- Click on "config.csv", and open or save the file.

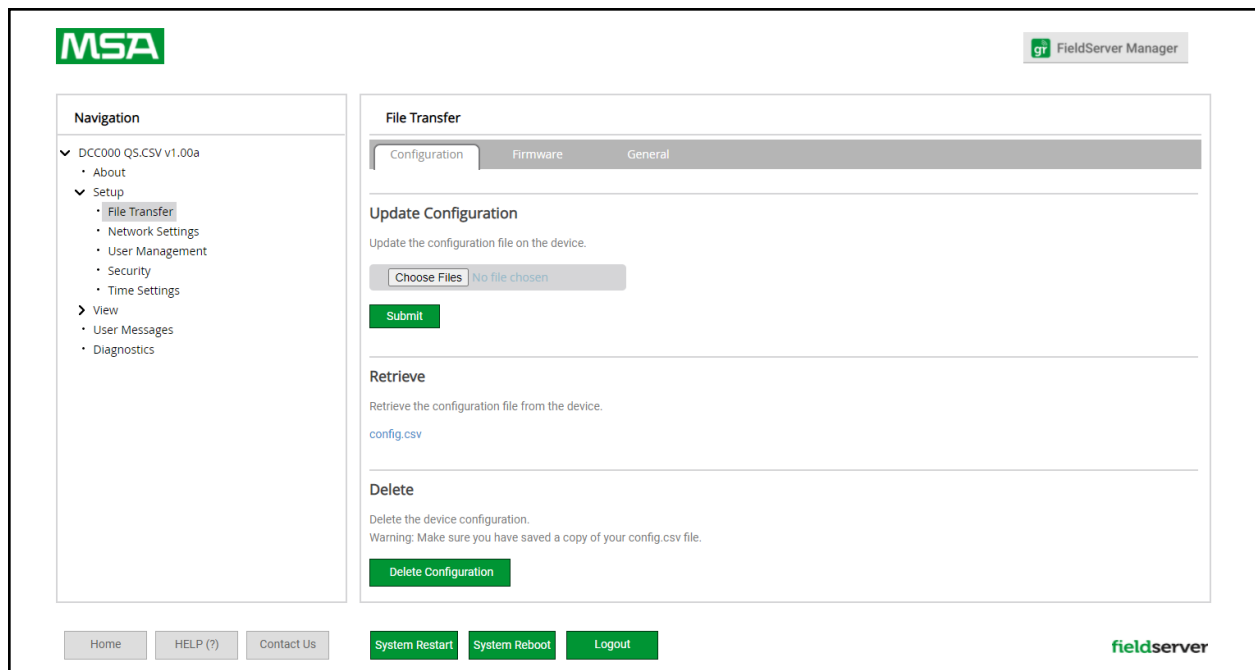

8.2 Change the Configuration File to Meet the Application

Refer to the FieldServer Configuration Manual in conjunction with the Driver supplements for information on configuring the QuickServer.

8.3 Load the Updated Configuration File

8.3.1 Using the FS-GUI to Load a Configuration File

- In the main menu of the FS-GUI screen, click “Setup”, then “File Transfer” and finally “Update”.
- Browse and select the .csv file, open, then click “Submit”.

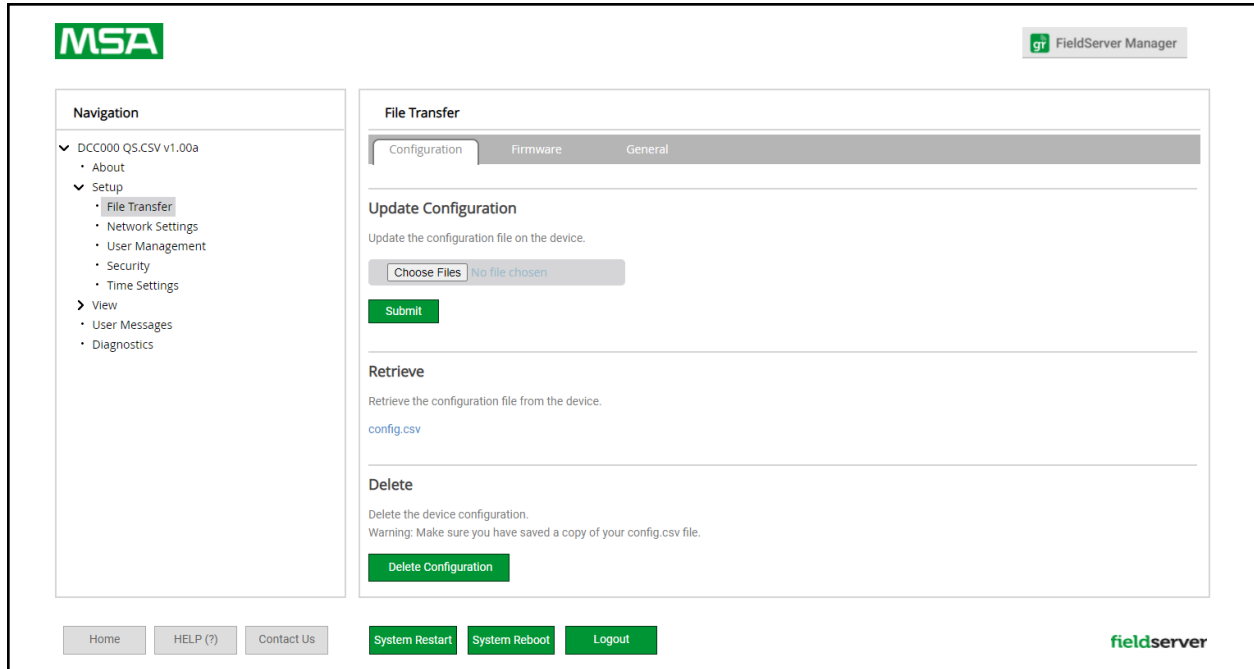

- Once download is complete, a message bar will appear confirming that the configuration was updated successfully.
- Click the System Restart Button to put the new file into operation.

NOTE: It is possible to do multiple downloads to the QuickServer before resetting it.

8.3.2 Retrieve the Configuration File for Modification or Backup

To get a copy of the configuration file for modifying or backing up a configuration on a local computer, do the following:

- In the main menu of the FS-GUI screen, click “Setup”, then “File Transfer”.

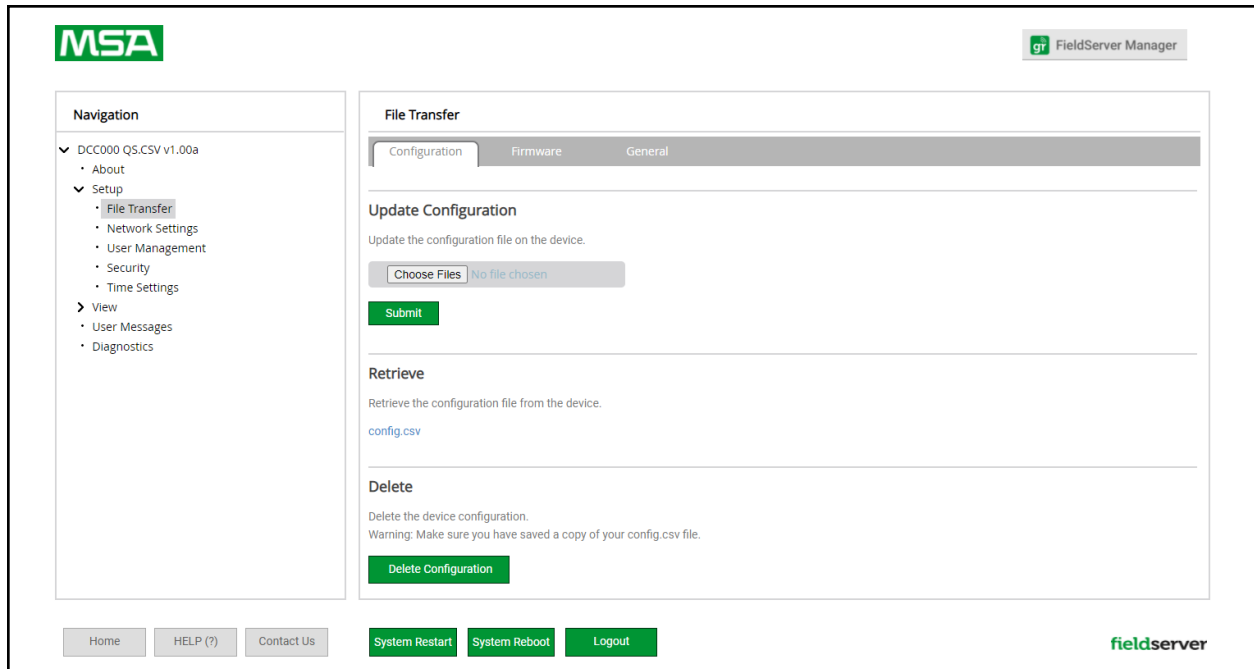

- Click the “config.csv” link under the “Retrieve” heading in the middle section of the screen.
 - The file will automatically download to the web browser’s default download location.
- Edit or store the file as desired.

NOTE: Before using any backup configuration file to reset the configuration settings, check that the backup file is not an old version.

8.4 Test and Commission the QuickServer

- Connect the QuickServer to the third party device(s), and test the application.
- From the landing page of the FS-GUI click on “View” in the navigation tree, then “Connections” to see the number of messages on each protocol.

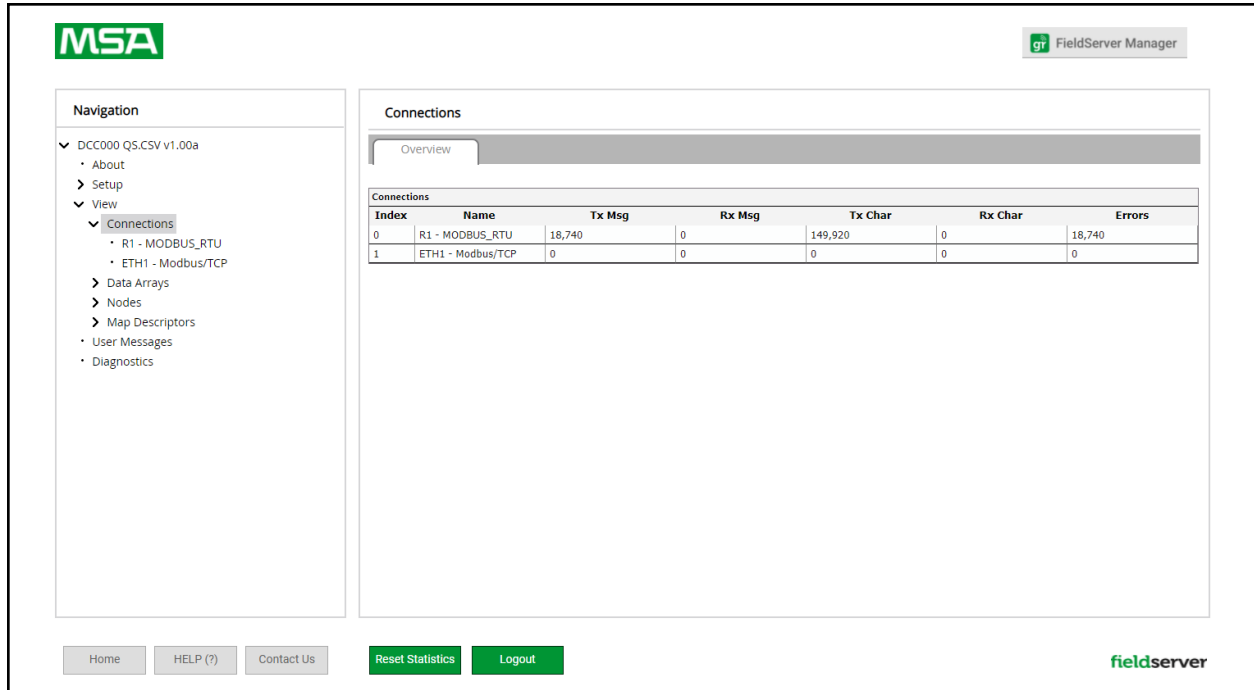

The screenshot displays the MSA FieldServer Manager interface. On the left is a navigation tree under 'DCC000 QS.CSV v1.00a' with options like 'About', 'Setup', 'View', 'Connections', 'Data Arrays', 'Nodes', 'Map Descriptors', 'User Messages', and 'Diagnostics'. The 'Connections' option is selected. The main area shows a 'Connections' table with columns: Index, Name, Tx Msg, Rx Msg, Tx Char, Rx Char, and Errors. The table contains two rows of data.

Index	Name	Tx Msg	Rx Msg	Tx Char	Rx Char	Errors
0	R1 - MODBUS_RTU	18,740	0	149,920	0	18,740
1	ETH1 - Modbus/TCP	0	0	0	0	0

At the bottom of the interface are buttons for 'Home', 'HELP (?)', 'Contact Us', 'Reset Statistics', and 'Logout'. The 'fieldserver' logo is in the bottom right corner.

NOTE: For troubleshooting assistance refer to [Section 10 Troubleshooting](#), or any of the troubleshooting appendices in the related driver supplements and configuration manual. MSA Safety also offers a technical support on the MSA Safety website, which contains a significant number of resources and documentation that may be of assistance.

8.4.1 Accessing the FieldServer Manager

NOTE: The FieldServer Manager tab  (see image above) allows users to connect to the Grid, MSA Safety’s device cloud solution for IIoT. The FieldServer Manager enables secure remote connection to field devices through a FieldServer and its local applications for configuration, management, maintenance. For more information about the FieldServer Manager, refer to the [MSA Grid - FieldServer Manager Start-up Guide](#).

9 MSA Grid - FieldServer Manager Setup

The MSA Grid is MSA Safety's device cloud solution for IIoT. Integration with the MSA Grid - FieldServer Manager enables the a secure remote connection to field devices through a FieldServer and hosts local applications for device configuration, management, as well as maintenance. For more information about the FieldServer Manager, refer to the [MSA Grid - FieldServer Manager Start-up Guide](#).

9.1 Registration Process

- After logging onto the QuickServer, go to the FS-GUI webpage and click the FieldServer Manager button

 in the top right corner of the page.

NOTE: If a warning message appears instead, go to [Section 11.6 FieldServer Manager Connection Warning Message](#) to resolve the connection issue.

Grid FieldServer Manager Registration

Securely access your FieldServer from anywhere with the **Grid FieldServer Manager**

Your one stop for managing your FieldServers and users

- ✓ **Secure Remote Access**
Securely connect your field devices to Grid FieldServer Manager.
- ✓ **FieldServer Management**
Manage all your FieldServers and connected devices from Grid FieldServer Manager and upgrade firmware remotely.
- ✓ **User Management**
Set up your user personnel with the right security permissions and FieldServer assignments for users to diagnose, configure, and better support the field installation.

For more information about Grid FieldServer Manager, visit [our website](#).

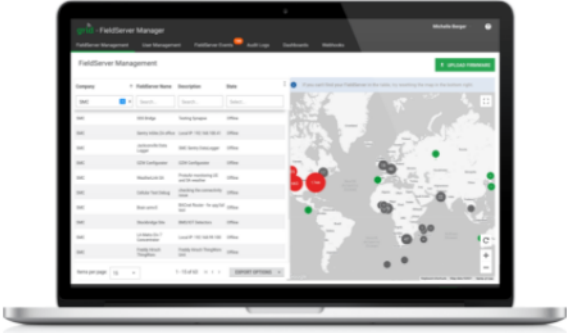

[Get Started](#)

- Click Get Started to view the FieldServer Manager registration page.

- To register, fill in the user details, site details, gateway details and account credentials.
 - Enter user details and click Next

1 Installer Details 2 Installation Site 3 FieldServer Details 4 Account Details

Installer Details

Installer Name

Company

Telephone

Email

Installation Date

- Enter the site details by entering the physical address fields or the latitude and longitude then click Next

Grid FieldServer Manager Registration

1 Installer Details 2 Installation Site 3 FieldServer Details 4 Account Details

Installation Site Details

Search

Site Name

Building

Street Address

Suburb

City

State

Country

Postal Code

Latitude

Longitude

- Enter Name and Description (required) then click Next

The screenshot shows the 'Grid FieldServer Manager Registration' process at step 3, 'FieldServer Details'. A progress bar at the top indicates four steps: 1. Installer Details, 2. Installation Site, 3. FieldServer Details (highlighted in green), and 4. Account Details. The form contains the following fields:

- Name:** A red rectangular input field.
- Description:** A red rectangular input field.
- FieldServer Info:** A text area with the placeholder text: 'Optionally specify any other information relating to the FieldServer i.e., calibration, commissioning or other notes'.
- Timezone:** A dropdown menu currently set to '(GMT -08:00) America/Los_Angeles'.

At the bottom right, there are three buttons: 'Cancel' (disabled), 'Previous' (disabled), and 'Next' (active).

- Click the “Create an Grid FieldServer Manager account” button

The screenshot shows the 'Grid FieldServer Manager Registration' process at step 4, 'Account Details'. The progress bar at the top shows step 4 highlighted in green. The section is titled 'New Users' and contains the following text and button:

If you do not have Grid FieldServer Manager credentials, you can create a new Grid FieldServer Manager account now

Create an Grid FieldServer Manager account (button)

- Enter a valid email and click the Create Account button to send a “Welcome to the MSA Grid” invite to the email address entered

The screenshot shows a dialog box titled 'Create Grid FieldServer Manager Account'. It contains the following text and fields:

Please enter your email address to create a Grid FieldServer Manager Account

Email Address [Red input field]

Email Address (confirm) [Red input field]

Create Account (button)

Close (button)

9.2 User Setup

Before the gateway can be connected to the FieldServer Manager, a user account must be created. Request an invitation to the FieldServer Manager from the manufacturer’s support team. Once an invitation has been requested (see **Section 9.1 Registration Process**), follow the instructions below to set up login details:

- The “Welcome to the MSA Grid - FieldServer Manager” email will appear as shown below.

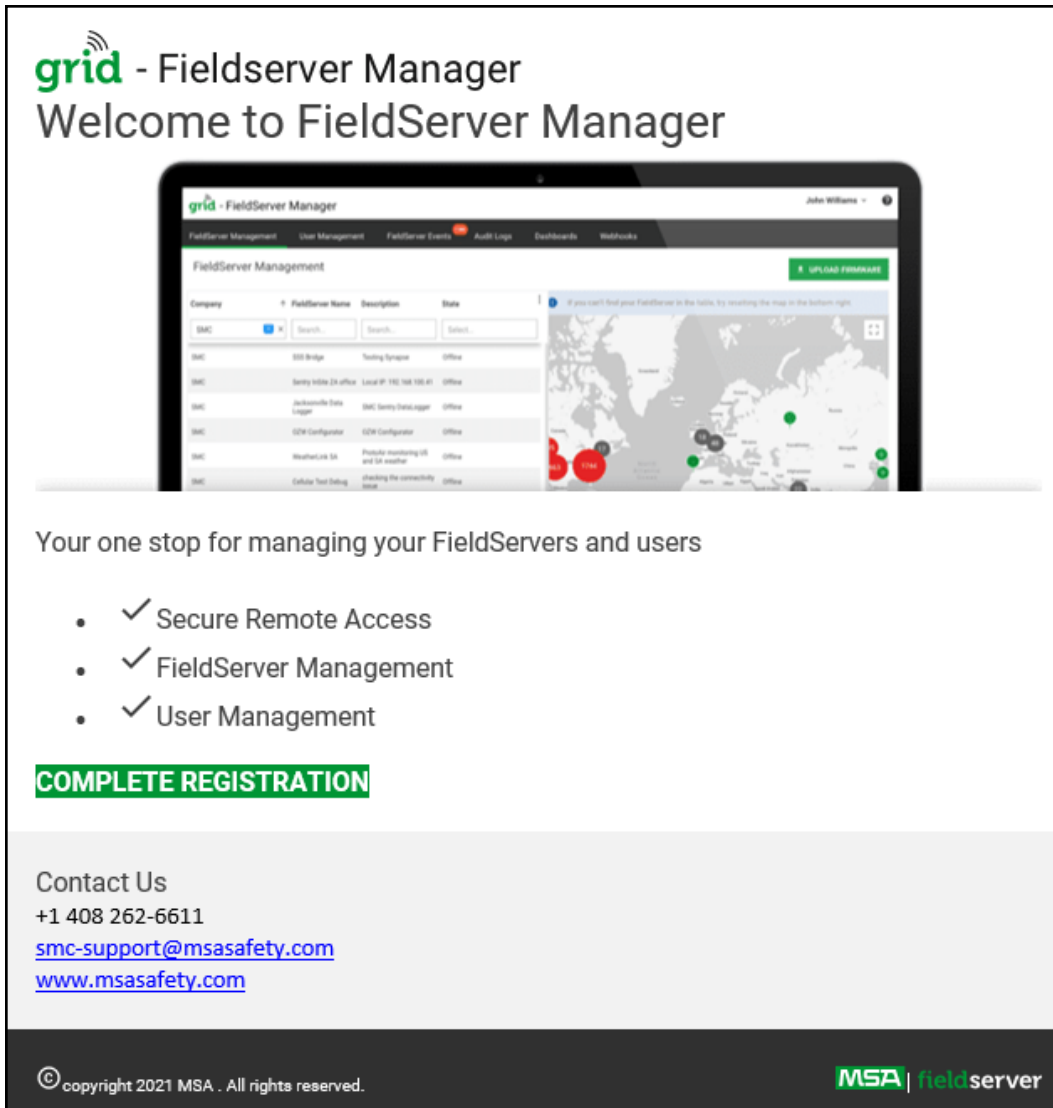

NOTE: If no email was received, check the spam/junk folder for an email from notification@fieldpop.io. Contact the manufacturer’s support team if no email is found.

- Click the “Complete Registration” button and fill in user details accordingly.

Complete Your Registration

Email Address

First Name
 *

Last Name
 *

Mobile Phone Number
 *

New Password *Invalid Mobile Number
 *

Confirm Password * Please enter new password
 *

By registering my account with MSA, I understand that I am agreeing to the FieldServer Manager [Terms of Service and Privacy Policy](#) *

* Mandatory Fields

- Fill in the name, phone number, password fields and click the checkbox to agree to the privacy policy and terms of service.

NOTE: If access to data logs using RESTful API is needed, do not include “#” in the password.

- Click “Save” to save the user details.
- Click “OK” when the Success message appears.
- Record the email account used and password for future use.

9.3 Finish Registering the FieldServer

- Enter the new Username and Password set up in **Section 9.2 User Setup**.

Grid FieldServer Manager Registration

1 Installer Details 2 Installation Site 3 FieldServer Details 4 Account Details

New Users

If you do not have Grid FieldServer Manager credentials, you can create a new Grid FieldServer Manager account now [Create an Grid FieldServer Manager account](#)

Existing Users - Enter FieldServer registration details

User Credentials

Username

Password

FieldServer Registration Complete

Congratulations! Your FieldServer is now registered with Grid FieldServer Manager

To remotely access this FieldServer, please log in at:
www.fieldpop.io

- Once the device has successfully been registered, a confirmation window will appear. Click the Close button and the following screen will appear listing the device details and additional information auto-populated by the QuickServer.

Grid FieldServer Manager Registration

FieldServer Registered

FieldServer Details Name: Test1 Description: FS Test FieldServer Info: Timezone: America/Los_Angeles MAC Address: 00:50:4E:60:13:FE Tunnel Server URL: tunnel.fieldpop.io FieldServer ID: treedancer_KrgPKmLRY Product Name: Core Application - Default Product Version: 5.2.0	Installer Details Installer Name: Test Company: MSA Safety Telephone: (408) 444-4444 Email: contactus@msasafety.com Installation Date: Sep 20, 2021	Installation Site Details Site Name: Site#1 Building: Street Address: 1020 Canal Road Suburb: City: Lafayette State: Indiana Country: United States Postal Code: 47904
---	--	---

[Update FieldServer Details](#)

NOTE: Update these details at any time by going to the device's FS-GUI webpage, clicking the FieldServer Manager button and then clicking the Update Device Details button.

9.4 Login to the FieldServer Manager

After the gateway is registered, go to www.smccloud.net and type in the appropriate login information as per registration credentials.

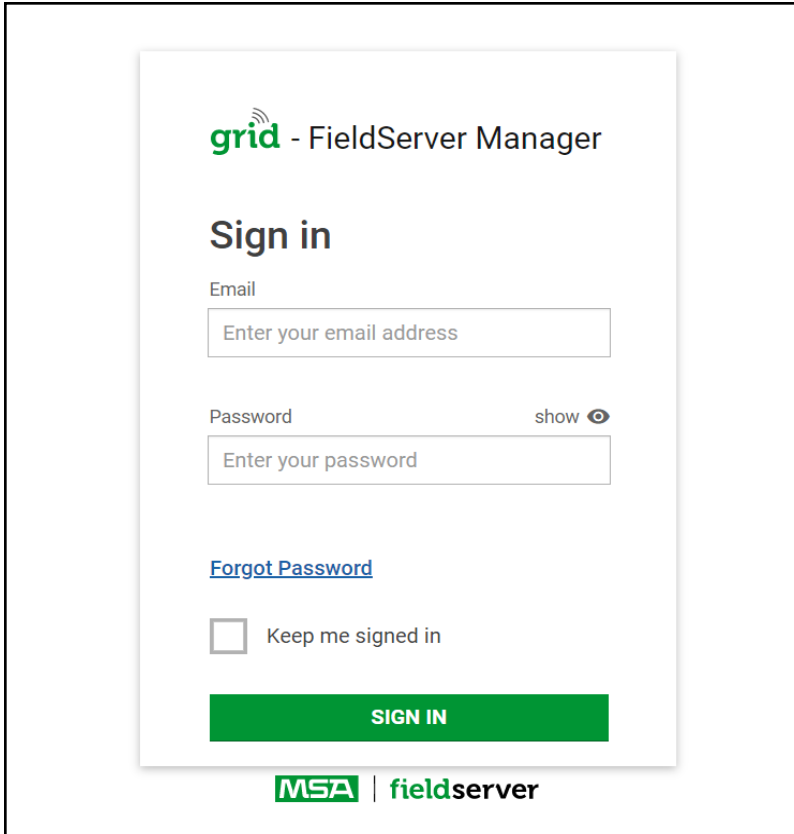

The screenshot shows the login interface for the FieldServer Manager. At the top, the logo 'grid' is displayed in green, followed by the text '- FieldServer Manager'. Below this is the heading 'Sign in'. There are two input fields: one for 'Email' with the placeholder text 'Enter your email address', and one for 'Password' with the placeholder text 'Enter your password'. To the right of the password field is a 'show' label with an eye icon. Below the password field is a blue link for 'Forgot Password'. There is a checkbox labeled 'Keep me signed in'. At the bottom of the form is a green button with the text 'SIGN IN'. At the very bottom of the page, the logos for 'MSA' and 'fieldserver' are displayed.

NOTE: If the login password is lost, see the [MSA Grid - FieldServer Manager Start-up Guide](#) for recovery instructions.

NOTE: For additional FieldServer Manager instructions see the [MSA Grid - FieldServer Manager Start-up Guide](#).

grid - FieldServer Manager

User A

FieldServer Management | User Management | FieldServer Events | Audit Logs | Dashboards | Webhooks

FieldServer Management

[↑ UPLOAD FIRMWARE](#)

If you can't find your FieldServer in the table, try resetting the map in the bottom right.

Company	FieldServer Name	Description	State
Eggers OEM	Jens's Brain 31	192.168.1.31	Offline
Eggers OEM	Jens MBP Core App	~/git/smc-core-application	Offline
Eggers OEM	Jens's Dell Profile View	~/git/profile-view	Offline
Eggers OEM	hd_test_log_to_fpop	testing_modbus	Offline
Eggers OEM	Mbus demo	testing registration	Offline
SMC	TestWall-PA2port 97	Testwall pa 2 97	Offline
SMC	TestWall-Lon152	Testwall unit	Offline

© 2021 MSA. All rights reserved. **MSA** | fieldserver

10 Troubleshooting

10.1 Communicating with the QuickServer Over the Network

- Confirm that the network cabling is correct.
- Confirm that the computer network card is operational and correctly configured.
- Confirm that there is an Ethernet adapter installed in the PC's Device Manager List, and that it is configured to run the TCP/IP protocol.
- Check that the IP netmask of the PC matches the QuickServer. The Default IP Address of the QuickServer is 192.168.2.X, Subnet Mask is 255.255.255.0.
 - Go to Start|Run
 - Type in "ipconfig"
 - The account settings should be displayed
 - Ensure that the IP Address is 102.168.2.X and the netmask 255.255.255.0
- Ensure that the PC and QuickServer are on the same IP Network, or assign a Static IP Address to the PC on the 192.168.2.X network.

10.2 Taking a FieldServer Diagnostic Capture

When there is a problem on-site that cannot easily be resolved, perform a Diagnostic Capture before contacting support. Once the Diagnostic Capture is complete, email it to technical support. The Diagnostic Capture will accelerate diagnosis of the problem.

- Access the FieldServer Diagnostics page via one of the following methods:
 - Open the FieldServer FS-GUI page and click on Diagnostics in the Navigation panel
 - Open the FieldServer Toolbox software and click the diagnose icon  of the desired device

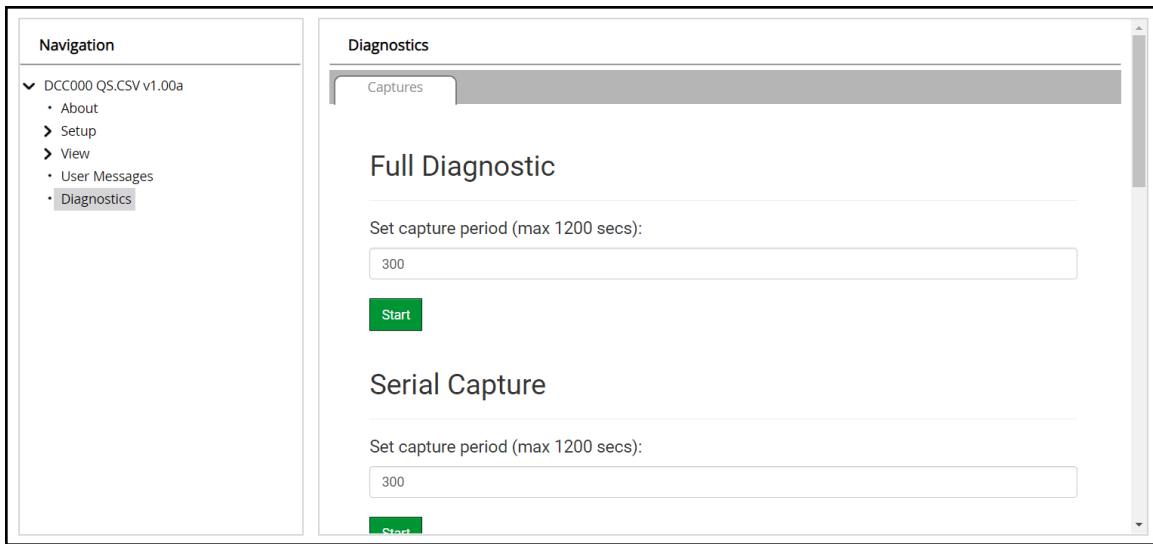

- Go to Full Diagnostic and select the capture period.
- Click the Start button under the Full Diagnostic heading to start the capture.
 - When the capture period is finished, a Download button will appear next to the Start button



- Click Download for the capture to be downloaded to the local PC.
- Email the diagnostic zip file to technical support (smc-support.emea@msasafety.com).

NOTE: Diagnostic captures of BACnet MS/TP communication are output in a “.PCAP” file extension which is compatible with Wireshark.

10.3 LED Functions

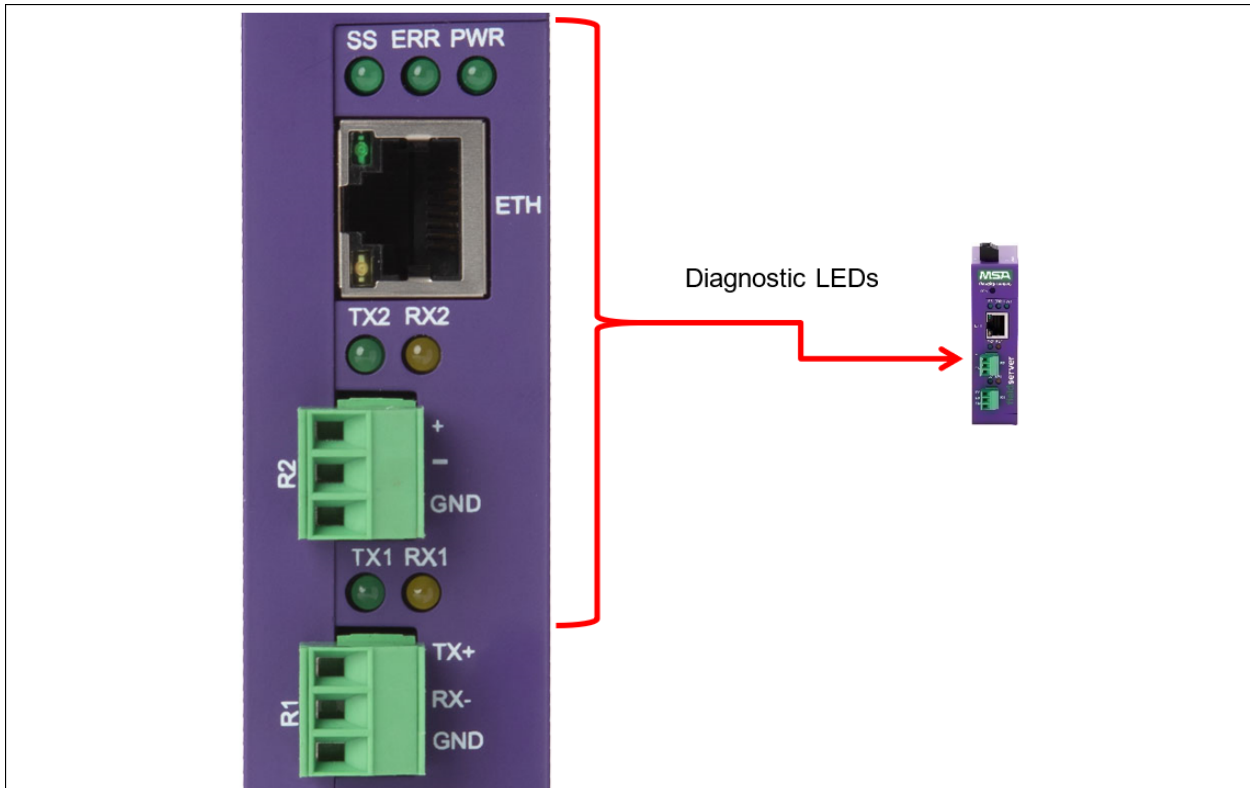

Tag	Description
SS	The SS LED will flash once a second to indicate that the bridge is in operation.
ERR	The SYS ERR LED will go on solid indicating there is a system error. If this occurs, immediately report the related "system error" shown in the error screen of the FS-GUI interface to support for evaluation.
PWR	This is the power light and should always be steady green when the unit is powered.
RX	The RX LED will flash when a message is received on the serial port on the 3-pin connector. If the serial port is not used, this LED is non-operational. RX1 applies to the R1 connection while RX2 applies to the R2 connection.
TX	The TX LED will flash when a message is sent on the serial port on the 3-pin connector. If the serial port is not used, this LED is non-operational. TX1 applies to the R1 connection while TX2 applies to the R2 connection.

10.4 Factory Reset Instructions

For instructions on how to reset a FieldServer back to its factory released state, see [ENOTE FieldServer Next Gen Recovery](#).

10.5 Internet Browser Software Support

The following web browsers are supported:

- Chrome Rev. 57 and higher
- Firefox Rev. 35 and higher
- Microsoft Edge Rev. 41 and higher
- Safari Rev. 3 and higher

NOTE: Internet Explorer is no longer supported as recommended by Microsoft.

NOTE: Computer and network firewalls must be opened for Port 80 to allow FieldServer GUI to function.

11 Additional Information

11.1 Change Web Server Security Settings After Initial Setup

NOTE: Any changes will require a FieldServer reboot to take effect.

- Navigate from the QuickServer landing page to the FS-GUI by clicking the blue “Diagnostics” text on the bottom of the screen.
- The QuickServer landing page is the FS-GUI.
- Click Setup in the Navigation panel.

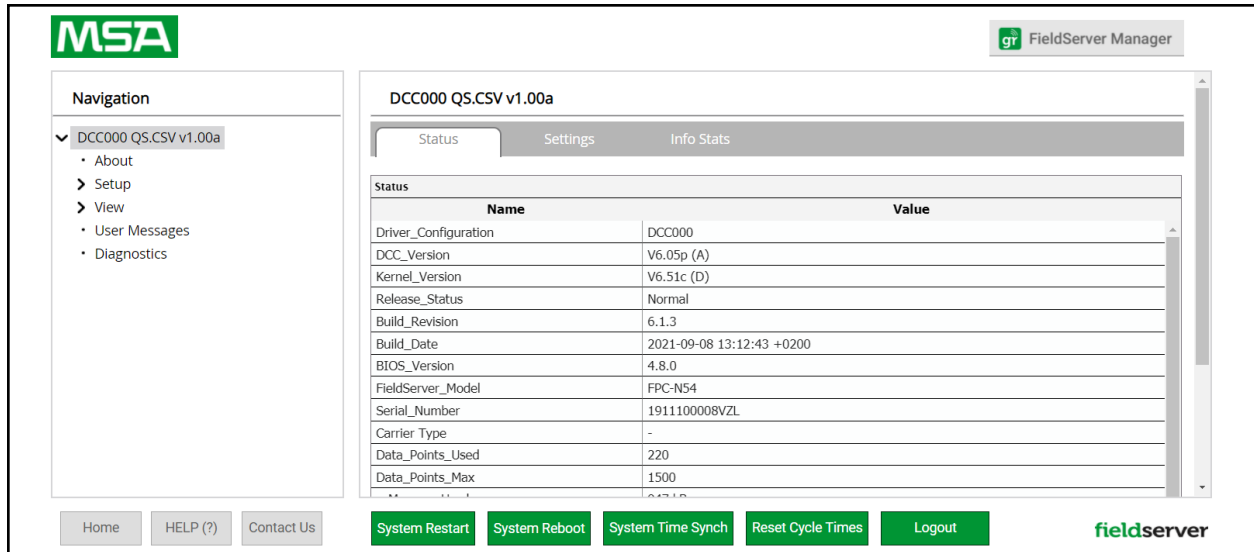

The screenshot displays the MSA FieldServer Manager web interface. On the left is a navigation menu with options: About, Setup, View, User Messages, and Diagnostics. The main content area is titled 'DCC000 QS.CSV v1.00a' and features tabs for Status, Settings, and Info Stats. The 'Status' tab is active, showing a table of system parameters:

Name	Value
Driver_Configuration	DCC000
DCC_Version	V6.05p (A)
Kernel_Version	V6.51c (D)
Release_Status	Normal
Build_Revision	6.1.3
Build_Date	2021-09-08 13:12:43 +0200
BIOS_Version	4.8.0
FieldServer_Model	FPC-N54
Serial_Number	1911100008VZL
Carrier_Type	-
Data_Points_Used	220
Data_Points_Max	1500

At the bottom of the interface, there are several action buttons: Home, HELP (?), Contact Us, System Restart, System Reboot, System Time Synch, Reset Cycle Times, and Logout. The 'fieldserver' logo is visible in the bottom right corner.

11.1.1 Change Security Mode

- Click Security in the Navigation panel.

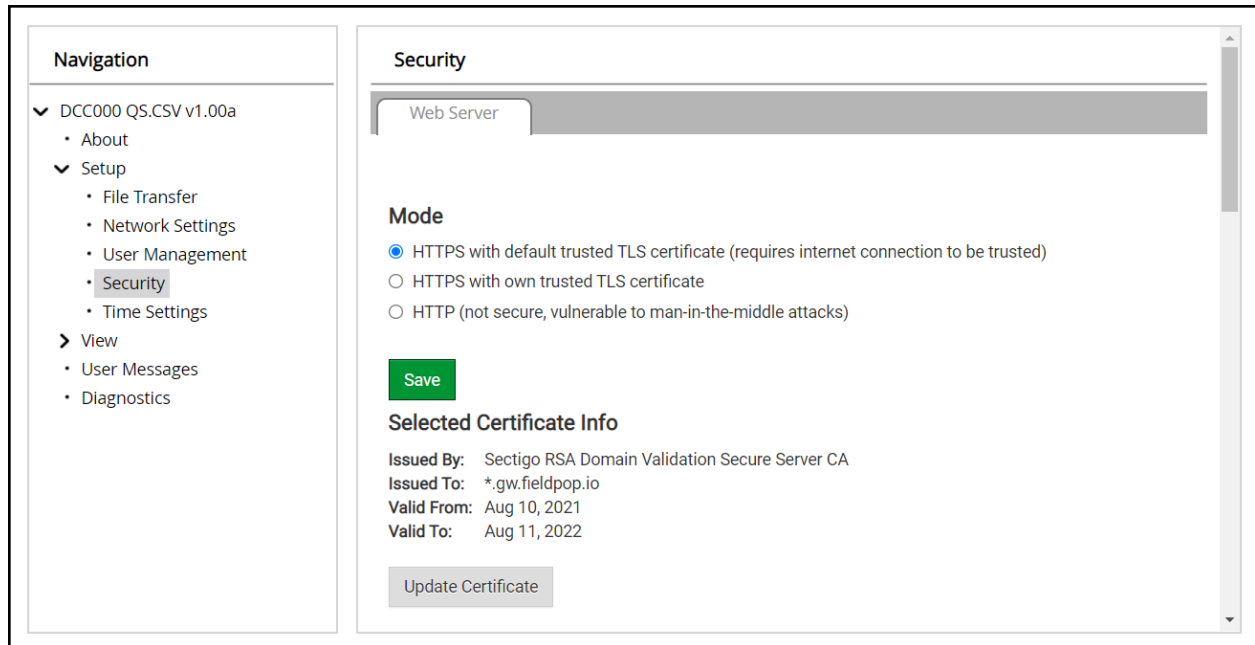

- Click the Mode desired.
 - If HTTPS with own trusted TLS certificate is selected, follow instructions in [Section 6.2.1 HTTPS with Own Trusted TLS Certificate](#)
- Click the Save button.

11.1.2 Edit the Certificate Loaded onto the FieldServer

NOTE: A loaded certificate will only be available if the security mode was previously setup as HTTPS with own trusted TLS certificate.

- Click Security in the Navigation panel.

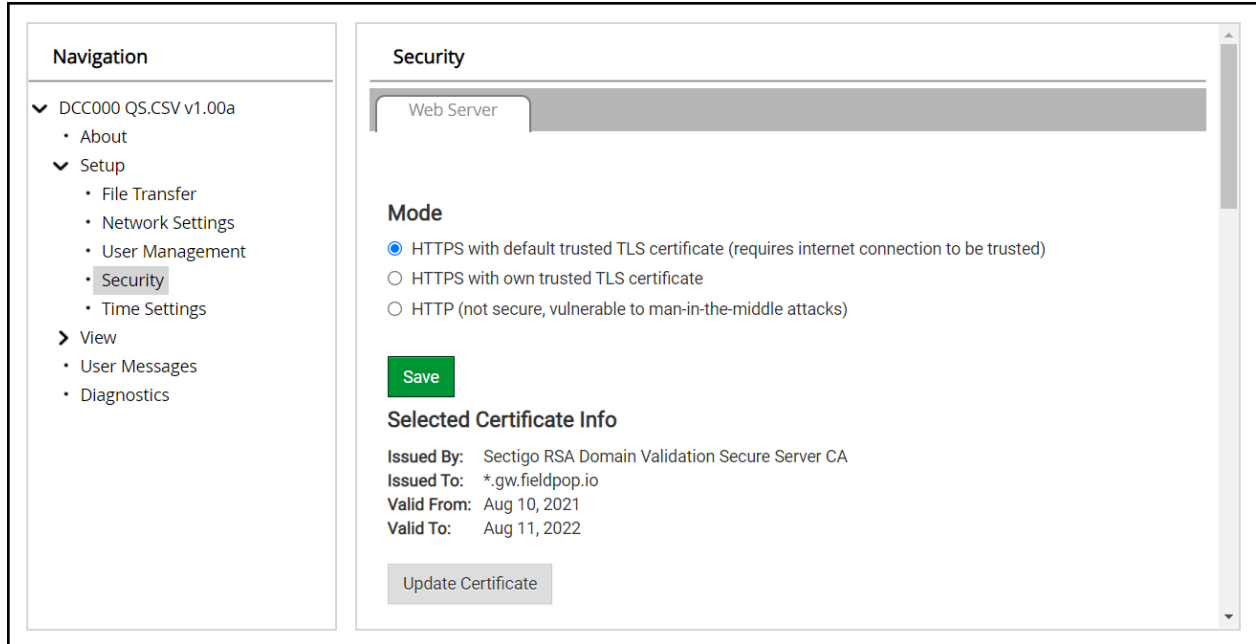

- Click the Edit Certificate button to open the certificate and key fields.
- Edit the loaded certificate or key text as needed.
- Click Save.

11.2 Change User Management Settings

- From the FS-GUI page, click Setup in the Navigation panel.
- Click User Management in the navigation panel.

NOTE: If the passwords are lost, the unit can be reset to factory settings to reinstate the default unique password on the label. For recovery instructions, see the [FieldServer Next Gen Recovery document](#). If the default unique password is lost, then the unit must be mailed back to the factory.

NOTE: Any changes will require a FieldServer reboot to take effect.

- Check that the Users tab is selected.

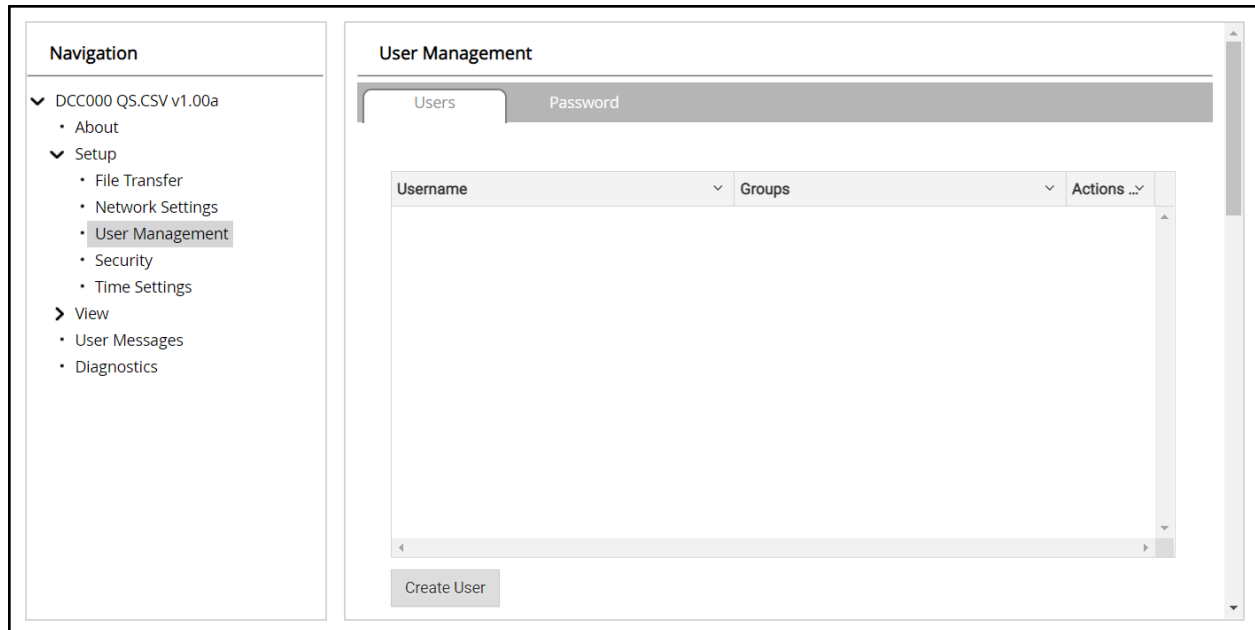

User Types:

Admin – Can modify and view any settings on the FieldServer.

Operator – Can modify and view any data in the FieldServer array(s).

Viewer – Can only view settings/readings on the FieldServer.

11.2.1 Create Users

- Click the Create User button.

Create User

Username:
Enter a unique username

Security Groups:

- Admin
- Operator
- Viewer

Password: Weak
Enter password

Show Passwords

Confirm Password:
Confirm password

Generate Password

Create Cancel

- Enter the new User fields: Name, Security Group and Password.
 - **User details are hashed and salted**

NOTE: The password must meet the minimum complexity requirements. An algorithm automatically checks the password entered and notes the level of strength on the top right of the Password text field.

- Click the Create button.
- Once the Success message appears, click OK.

11.2.2 Edit Users

- Click the pencil icon next to the desired user to open the User Edit window.

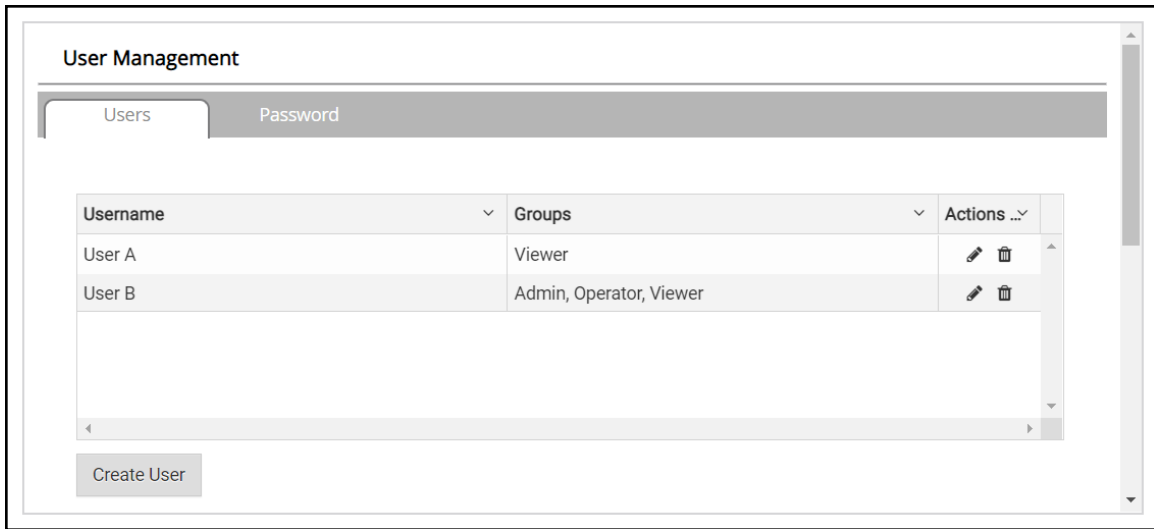

- Once the User Edit window opens, change the User Security Group and Password as needed.

The 'Edit User' dialog box is shown. It has the following fields and options:

- Username:** A text input field containing 'User A'.
- Security Groups:** Three checkboxes: 'Admin' (unchecked), 'Operator' (unchecked), and 'Viewer' (checked).
- Password:** A text input field containing 'Optional'.
- Show passwords
- Confirm Password:** A text input field containing 'Optional'.
-
- (green)
-

- Click Confirm.
- Once the Success message appears, click OK.

11.2.3 Delete Users

- Click the trash can icon next to the desired user to delete the entry.

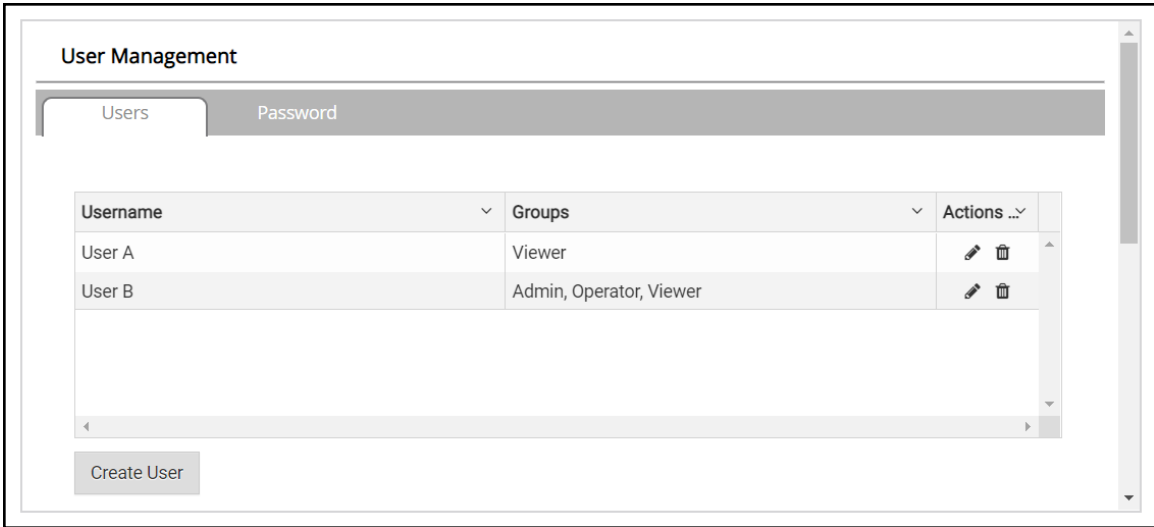

- When the warning message appears, click Confirm.

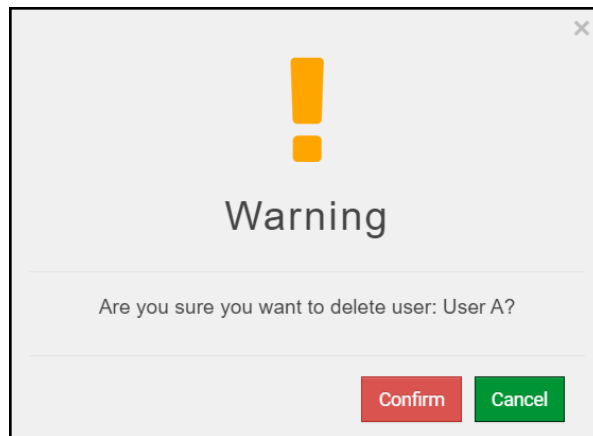

11.2.4 Change FieldServer Password

- Click the Password tab.

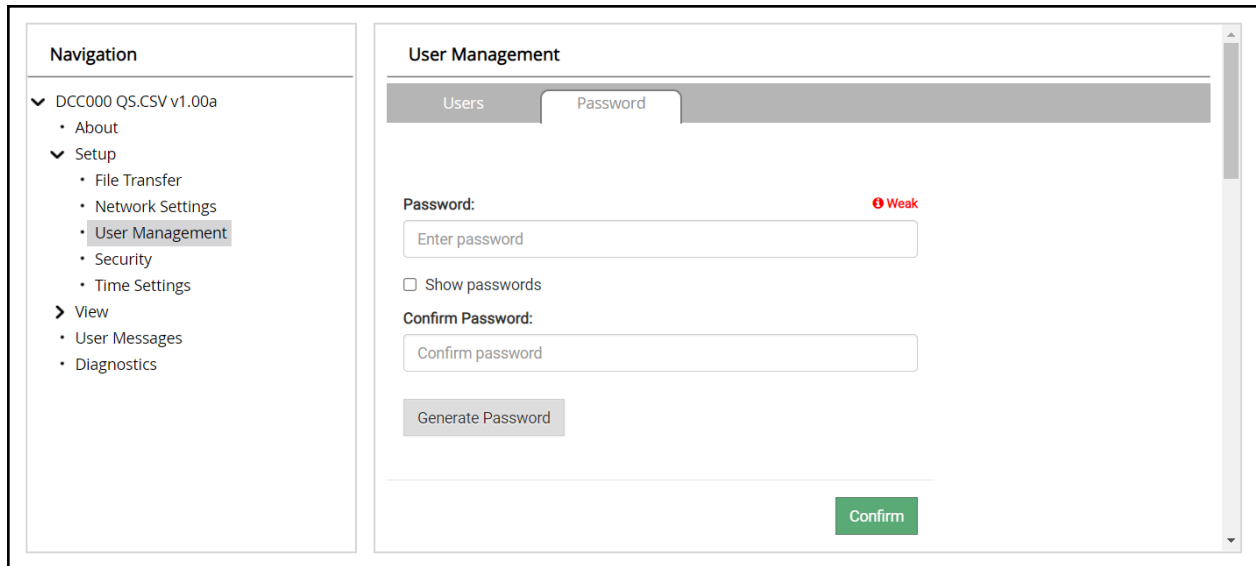

The screenshot shows a web interface for 'User Management' with two tabs: 'Users' and 'Password'. The 'Password' tab is active. On the left is a 'Navigation' sidebar with a tree structure: 'DCC000 QS.CSV v1.00a' (expanded) containing 'About', 'Setup' (expanded), 'View', 'User Messages', and 'Diagnostics'. Under 'Setup', 'User Management' is highlighted. The main content area has a 'Password:' label with a red 'Weak' indicator and a 'Show passwords' checkbox. Below are 'Enter password' and 'Confirm password' text fields, a 'Generate Password' button, and a 'Confirm' button at the bottom right.

- Change the general login password for the FieldServer as needed.

NOTE: The password must meet the minimum complexity requirements. An algorithm automatically checks the password entered and notes the level of strength on the top right of the Password text field.

11.3 QuickServer Part Numbers

QuickServer	Interface Connections					
	RS-232 ¹	RS-485 ²	KNX ⁵	M-Bus	Ethernet ³	LonWorks ⁴
FS-QS-2X10	1	2			1	
FS-QS-2X20	1	2			1	
FS-QS-1011		1			1	1
FS-QS-1211		1			1	1
FS-QS-1221	1				1	1
FS-QS-1240		1	1		1	
FS-QS-1241			1		1	1
FS-QS-1A50		1		1	1	
FS-QS-1A51				1	1	1
FS-QS-1B50		1		1	1	
FS-QS-1B51				1	1	1
FS-QS-1C50		1		1	1	
FS-QS-1C51				1	1	1

¹ TX/Rx/GND ² +/-/Frame Ground

³ 10/100 Base T

⁴ FTT10

⁵ KNX/EIB TP1

NOTE: The 2X10 and 2X20 are the same hardware model with 1 port that can be either RS-232 or RS-485. The 2X10 has a default setting of RS-485 while the 2X20 has a default setting of RS-232.

11.4 Compliance with UL Regulations

For UL compliance, the following instructions must be met when operating the QuickServer.

- The units shall be powered by listed LPS or Class 2 power supply suited to the expected operating temperature range.
- The interconnecting power connector and power cable shall:
 - Comply with local electrical code
 - Be suited to the expected operating temperature range
 - Meet the current and voltage rating for the FieldServer
- Furthermore, the interconnecting power cable shall:
 - Be of length not exceeding 3.05m (118.3")
 - Be constructed of materials rated VW-1, FT-1 or better
- If the unit is to be installed in an operating environment with a temperature above 65 °C, it should be installed in a Restricted Access Area requiring a key or a special tool to gain access.
- This device must not be connected to a LAN segment with outdoor wiring.

11.5 Specifications



FS-QS-2XX0-XXXX	
Electrical Connections	One 3-pin Phoenix connector with: RS-485/RS-232 (Tx+ / Rx- / gnd) One 3-pin Phoenix connector with: RS-485 (+ / - / gnd) One 3-pin Phoenix connector with: Power port (+ / - / Frame-gnd) One Ethernet 10/100 BaseT port
Power Requirements	<i>Input Voltage:</i> 9-30VDC or 24VAC <i>Max Power:</i> 3 Watts <i>Current draw:</i> 24VAC 0.125A 9-30VDC 0.25A @12VDC
Approvals	CE and FCC Part 15 B & C, UL 60950-1 and CAN/CSA C22.2, WEEE compliant, RoHS compliant, DNP 3.0 and Modbus conformance tested, REACH compliant, UKCA compliant
Capacity Options	FS-QS-20X0: 250 data points FS-QS-22X0: 500 data points FS-QS-21X0: 1,000 data points FS-QS-23X0: 3,000 data points FS-QS-24X0: 5,000 data points
Physical Dimensions	4 x 1.1 x 2.7 in (10.16 x 2.8 x 6.8 cm)
Weight	0.4 lbs (0.2 Kg)
Operating Temperature	-20°C to 70°C (-4°F to 158°F)
Humidity	10-95% RH non-condensing

“This device complies with part 15 of the FCC Rules. Operation is subject to the following two conditions:

- This device may not cause harmful interference
- This device must accept any interference received, including interference that may cause undesired operation.

NOTE: This equipment has been tested and found to comply with the limits for a Class A digital device, pursuant to part 15 of the FCC Rules. These limits are designed to provide reasonable protection against harmful interference when the equipment is operated in a commercial environment. This equipment generates, uses, and can radiate radio frequency energy and, if not installed and used in accordance with the instruction manual, may cause harmful interference to radio communications. Operation of this equipment in a residential area is likely to cause harmful interference in which case the user will be required to correct the interference at his expense.

Modifications not expressly approved by FieldServer could void the user's authority to operate the equipment under FCC rules.”

NOTE: Specifications subject to change without notice.

11.6 FieldServer Manager Connection Warning Message

- If a warning message appears instead of the page as shown below, follow the suggestion that appears on screen.
 - If the FieldServer cannot reach the server, the following message will appear

Grid FieldServer Manager Registration

Grid FieldServer Manager™ Server Unreachable

The device is unable to connect to the Grid FieldServer Manager server.

The following network issues have been detected. Correcting them might resolve connectivity to the server:

- Could not ping Gateway [192.168.2.1]
- Could not ping Domain Name Server 1 [8.8.8.8]
- Could not ping Domain Name Server 2 [8.8.4.4]

Ensure your network firewall is configured to allow this device to access the Grid FieldServer Manager server:

- Error Code: **EALAGAIN**
- FieldServer MAC address: **00:50:4E:60:6C:E8**
- Allow HTTPS communications to the following domains on **port 443**:
 - **www.fieldpop.io**
 - **ts.fieldpop.io**

- Follow the directions presented in the warning message.
 - Go to the network settings by clicking the Settings tab and then click the Network tab
 - Check with the site's IT support that the DNS settings are setup correctly
 - Ensure that the FieldServer is properly connected to the Internet

NOTE: If changes to the network settings are done, remember to click the **Save** button. Then power cycle the FieldServer by clicking on the **Confirm** button in the window and click on the bolded "Restart" text in the yellow pop-up box that appears in the upper right corner of the screen.

12 Limited 2 Year Warranty

MSA Safety warrants its products to be free from defects in workmanship or material under normal use and service for two years after date of shipment. MSA Safety will repair or replace any equipment found to be defective during the warranty period. Final determination of the nature and responsibility for defective or damaged equipment will be made by MSA Safety personnel.

All warranties hereunder are contingent upon proper use in the application for which the product was intended and do not cover products which have been modified or repaired without MSA Safety's approval or which have been subjected to accident, improper maintenance, installation or application; or on which original identification marks have been removed or altered. This Limited Warranty also will not apply to interconnecting cables or wires, consumables or to any damage resulting from battery leakage.

In all cases MSA Safety's responsibility and liability under this warranty shall be limited to the cost of the equipment. The purchaser must obtain shipping instructions for the prepaid return of any item under this warranty provision and compliance with such instruction shall be a condition of this warranty.

Except for the express warranty stated above, MSA Safety disclaims all warranties with regard to the products sold hereunder including all implied warranties of merchantability and fitness and the express warranties stated herein are in lieu of all obligations or liabilities on the part of MSA Safety for damages including, but not limited to, consequential damages arising out of/or in connection with the use or performance of the product.